

PLAN VIEW

	CHAMBER	Volume (gal)
①	Sedimentation Chamber	198
②	Anaerobic Filtration Chamber	198
③	Aerobic Contact Filtration Chamber	95
④	Clarification Chamber	44
⑤	Disinfection Chamber	4
Total Volume		540

SPECIFICATIONS	
Anaerobic Media	PP / PE
Board Type Aerobic Media	PVC / PP / PE
Aerobic Media	PP / PE
Blower	2.8 cfm
Tank	FRP
Piping	PVC / PP / PE
Access Covers	Plastic / Cast Iron
Disinfectant (Optional)	Chlorine Tablets

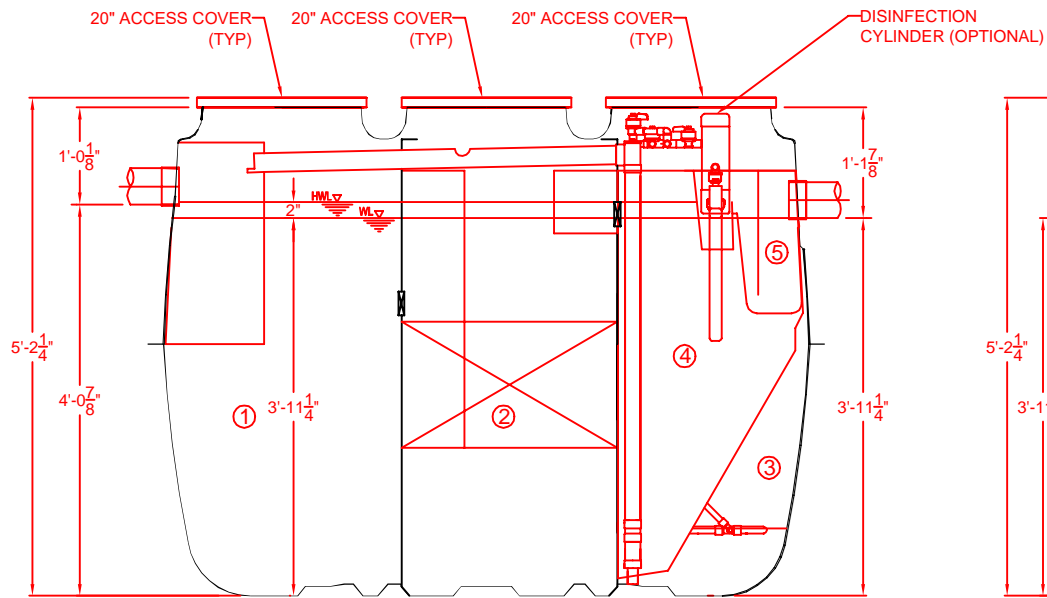

SECTION A-A VIEW

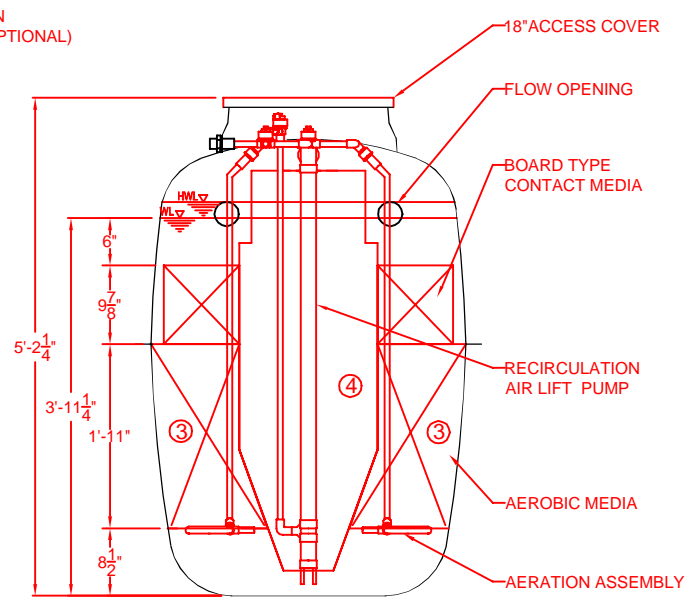

SECTION B-B VIEW



CE-5
Structural Drawing

DATE: 03/21/2020 SCALE: 1/2" = 1"