

**Contractor Installation Manual**  
**Residential and Commercial Systems**  
Including  
**H-20 Installation**

**CE and CEN Models**  
(except Model CE6KG)

Rev. January, 2022



Certified to  
NSF/ANSI Standards 40 & 245

**Please Note:**

1. **Product warranty requires proper system installation as described in this Manual.**
2. **It is the responsibility of the installing contractor to understand and adhere to all federal, state and local health and safety regulations.**

**Warranty Activation.** To activate system warranty, FujiClean USA must receive Warranty Activation Card!



## Installation Manual - CE and CEN Models

### Introduction

This manual describes proper installation of FujiClean USA's models CE and CEN wastewater treatment systems. The manual is divided into the following sections:

1.	Equipment Supplied <u>to</u> Contractor	Page 3
2.	Materials Supplied <u>by</u> Contractor	Page 5
3.	Installation Overview	Page 6
4.	Treatment Process Overview	Page 8
5.	System Components and Specification Summary	Page 9
6.	Riser Installation	Page 10
7.	No-Traffic Area Installation Procedure	Page 12
	Uplift Restraint	Page 13
8.	Options for H-20, HS-20 Installations	
	● Traffic-Rated Vault Technique	Page 22
	● Poured Top Slab Technique	Page 24
	● Support Column Technique	Page 31
9.	Control/Alarm Panel Options	Page 39
	● Control Panel "M"	Page 40
	● Control Panel "A"	Page 43
	● Float Switch Information	Page 46
8.	Start-up Procedures	Page 47
9.	Installation Checklist	
	● No-Traffic Area	Page 50
	● Traffic-Rated Tank and No Support Columns	Page 52
	● Support Columns	Page 54







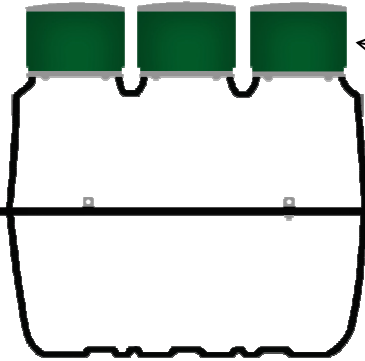

## Residential Models

CE5, CE7 and CE10

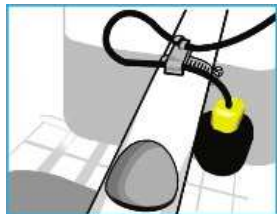
CEN5, CEN7 and CEN10

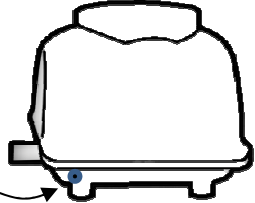
Thank you for choosing to install a FujiClean treatment system. We care that the system is installed properly and thoughtfully. FujiClean USA or your qualified distributor will train and certify you for proper installation. Please note: Supplied components may vary according to model and state. Please call FujiClean USA with questions.

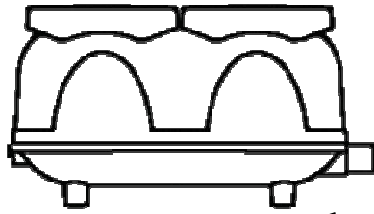





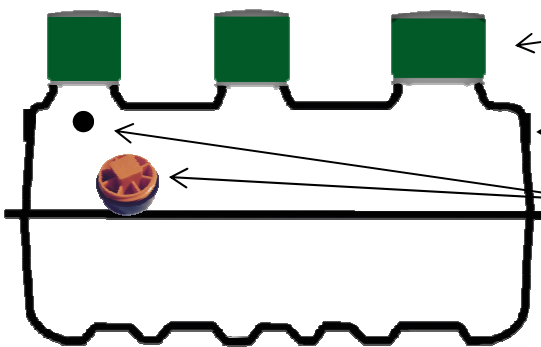
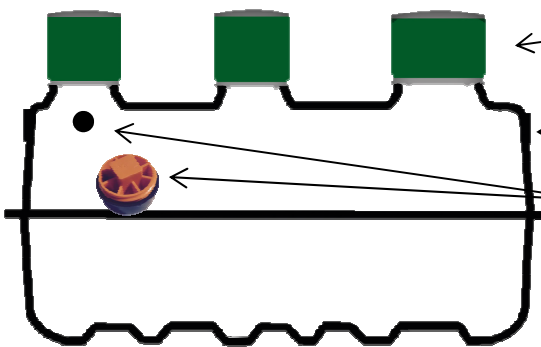
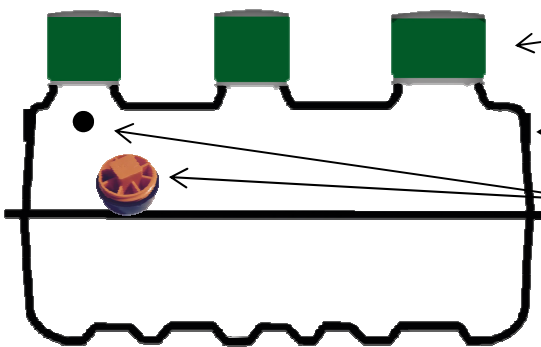

### Equipment Supplied to Contractor

- 
 Risers & Covers (May vary – check with local distributor)
- 
 FujiClean Treatment System
- 
 Alarm / Control Panel (NEMA 4X Rated)
- 
 Signal Master Float Switch (Affix to pumpback line in center chamber with 3-1/2" tether)
- 
 1/8" (ID) Vinyl Micro-Tubing for Air Pressure Sensing Alarm (Not included on panels with current sensors.)
- 
 FujiMAC UL Approved Air Pump -Residential Series (For models CE5, CE7, CE10, CEN5, CEN7)
- 
 Air Pressure Line Barb (Screws with rubber washer into pump)
- 
 Air line to Air Pump Adapter  $\phi 13 - 3/4$ inch (Unglued. Clamp during installation.) (CE5, CE7, CE10, CEN5, CEN7)
- 
 FujiMAC UL Approved Air Pump -Commercial Series (For model CEN10)
- Installation Manual, User's Manual, Warranty Card
- 
 NSF Dataplates (2)

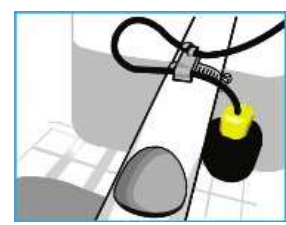
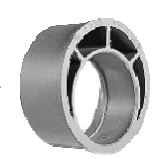

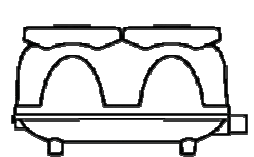
Thank you for choosing to install a FujiClean treatment system. We care that the system is installed properly and thoughtfully. FujiClean USA or your qualified distributor will train and certify you for proper installation. Please note: Supplied components may vary according to model and state. Please call FujiClean USA with questions.

### Equipment Supplied to Contractor

- 
❑ Risers & Covers (May vary – check with local distributor)
- 
❑ FujiClean Treatment System Tank
- 
❑ Air Vent Hole and Plug  
(Tighten clockwise. Plugs the vent hole if venting through building. Note: some models have two vent holes.)
- 
❑ Alarm / Control Panel  
(NEMA 4X Rated)
- 
❑ Signal master Float Switch  
(Affix to pumpback line in center chamber with 3-1/2" tether)
- 
❑ Eccentric Inlet/Outlet 5x4 Bushing (2) →  
(Except CE14)
- 
❑ Air Pump adaptor Fitting with Barb  
(Not provided or necessary with "M" Alarm Panel)
- 
❑ FujiMAC UL Approved Air Pump(s) –  
Commercial Series (Size and quantity based on treatment system model.)
- 
❑ 1/8" (ID) Vinyl Micro-Tubing for Air Pressure Sensing Alarm.  
(Not included on panels with current sensors.)
- 
❑ Installation Manual, User's Manual, Warranty Card
- 
❑ NSF Dataplates (2) →  
(Except CE21, CE30 and CEN21)



# Contractor Installation Manual

## Equipment Supplied by Contractor

### **Risers and Access covers per Site & Regulatory Requirements**

- Risers in 6" or 12" height increments and access covers are typically available from your distributor. If not already installed, please refer to installation instructions in this Manual.
- Maximum riser height is 24 inches for No Traffic load and H-20, HS-20 with Support Columns.
- For H-20, HS-20 with No Support Columns (i.e. poured slab), acceptable riser height is 12 inches, with a total depth maximum of 24 inches between ground level and tank adapter ring.

**Model CE5:** Three (3) 20" diameter risers

**Models CE7 - CE30 and CEN Series:** Two (2) 20" diameter risers plus One (1) 24" diameter riser.

### **Insulation for Cold Climate Installations**

- To maintain optimal treatment conditions, FujiClean recommends insulated access covers as well as foam board or insulating material (min. R-Value 8) over the upper half of the tank.
- With H-20, HS-20 with No Support Columns installation, insulate at depth of 24 inches from ground level.

### **Septic Tank and/or Pump Station.**

- FujiClean Treatment systems are designed to accept straight wastewater. However, some treatment train designs, especially commercial systems, call for pretreatment, settling and/or trash tanks. Treated effluent gravity flows from Fuji Clean systems. A separate pump tank is necessary if site or design dictates.

### **Fresh Water**

- Systems must be filled with fresh water to Low Water Level in all three tank chambers before backfill. Please refer to gallon "Volume Total" on page 9.

### **Piping / Conduit**

- Smaller models have inlet/outlet adapters for Sched. 40 4" pipe. Models CE14, CE21, CE30, CEN14, CEN21 fittings are for 5" sched. 40 pipe and come with a 5": 4" eccentric adapters, to accommodate sched. 40 4" pipe.
- ¾" or 1" PVC conduit for air line. Please refer to table on page 16 of this Manual for sizing.
- Electrical conduit for float switch line (direct burial line is also acceptable if allowed by code).

### **Electrical**

- Please use licensed electrician and adhere to applicable national/local electrical code(s).
- Two (2) standard 115V, 15A circuits for control/alarm panel connection.
- Float Switch Wire: #18 AWG, comes with standard 30' length. (Longer lengths are available on request).
- Miscellaneous fittings and connectors to ensure watertight connections.

### **Anti-Float Devices, if necessary**

- Please refer to high water, uplift restraint recommendations on page 13 in this Manual.

### **Materials for Air Pump / Controller Installation**

- Concrete base (or equivalent) on which to set air pump.
- Protective cover for air pump (recommended) vented and able to achieve free air flow in all conditions.
- Materials or location on which to mount control panel and directly protect from elements.

### **Crushed Stone, Fill, Loam etc.**

- FujiClean USA is not responsible for design, installation or materials associated with leach field or treated wastewater disposal area.

**Please note: Proper installation permitting is the responsibility of the installing contractor.**

# Installation Overview

## Residential Models CE5, CE7 and CE10 CEN5, CEN7 and CEN10

FujiClean recommends a protective housing with solid base for air pump placement. Contractor to supply material to locate and mount the alarm/control panel.

System vents through house vent system. For houses with house traps installed, vent system separately through vent hole in tank.

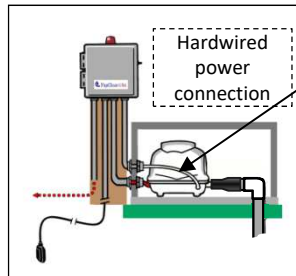
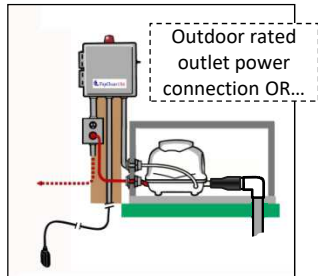

1/8" Air pressure line is not supplied with panels that use current sensors.

3/4" or 1" air line conduit connection to tank. Refer to sizing table on page 16 of this Manual. Air line should be less than 100' and have 5 or fewer "elbows." (If site conditions will not allow, please contact FujiClean for air pump upsize calculation).

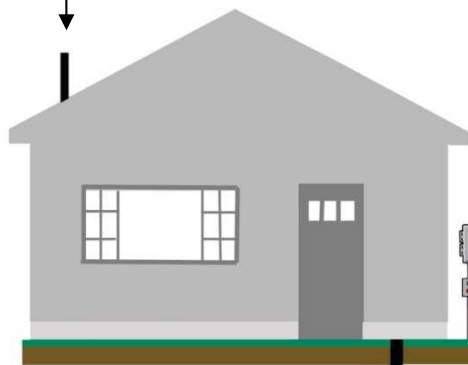

Site in accessible location with proximity to alarm panel. See additional placement notes in Installation Manual.



Adapters and fittings, when necessary, are supplied by FujiClean USA for connection between treatment system and air pump.

Systems will be typically delivered with 6" risers affixed. Contractor shall supply additional layers if necessary to 24" maximum riser height.

4" PVC inlet and outlet pipe

4-point lifting lugs. Use for setting tank. Tank must be level to within 1/8". Do not use lifting lugs for uplift restraint.

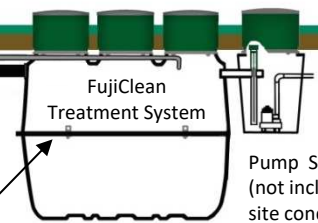

**Please Note for Residential and Commercial units;**

1. Fujiclean Treatment systems are designed to accept straight wastewater. However, some treatment train designs, especially commercial systems, call for pretreatment, settling and/or trash tanks.
2. Fill tank with fresh water to LWL (Low Water Level) mark in all three chambers once tank is set.
3. See Installation Manual for uplift restraint detail.
4. "Clearwater" water softener backwash should be discharged directly to a separate drywell, leaching pool or other approved area.
5. Use licensed electrician for final wiring.
6. Affix NSF labels in two locations, inside the inlet riser and on the inside of the controller. (Does not apply to models CE21, CE30 and CEN21)
7. Installing contractor responsible for final landscaping, seeding etc. Be certain that final grade pitches away from treatment tank covers.
8. Final inspection and startup shall be the responsibility of the FujiClean USA certified O&M provider.
9. Homeowner manual must be provided to, and reviewed with, homeowner to assure proper use.
10. Warranty Card (orange card supplied by FujiClean USA), must be returned to FujiClean USA to activate warranty.

Bed tanks in 4"-6" sand or suitable (no rocks) native soil .

Fill set tank with fresh water to low water mark in all 3 chambers.

Backfill in tamped lifts with suitable native soil, sand, peastone or equivalent that form fits to tank. No sharp rocks!

Float switch to alarm panel connection: Drill hole in riser. Use male fitting and electrical conduit. Plug with sealant for water-tight seal. Install on the recirculation line using provided hose clamp in the center of 2<sup>nd</sup> chamber with 3-1/2" tether.

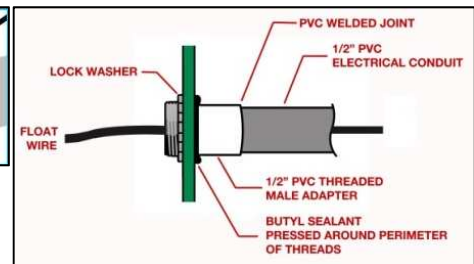
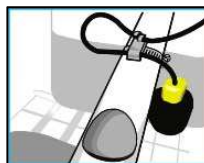



# Installation Overview

## Commercial Models

CE14, CE21 and CE30  
CEN14 and CEN21

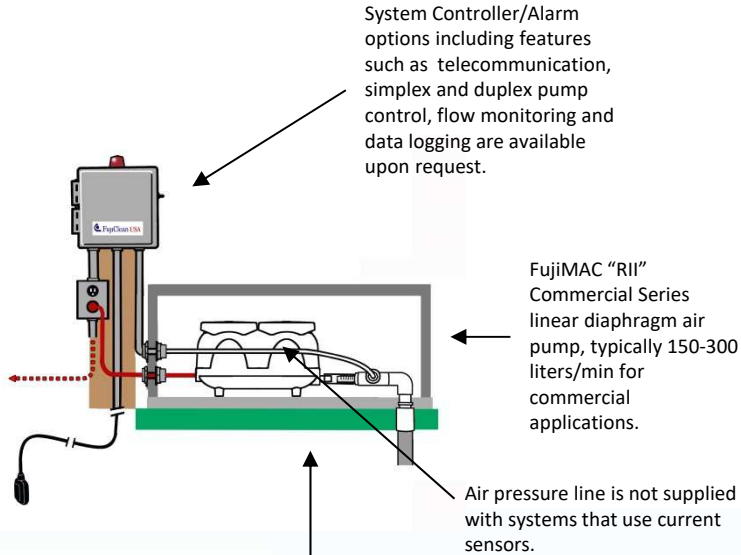

Multiple system configurations may be controlled independently (shown) or by one customized controller.



Systems may be clustered in parallel configuration for treatment of larger flows.

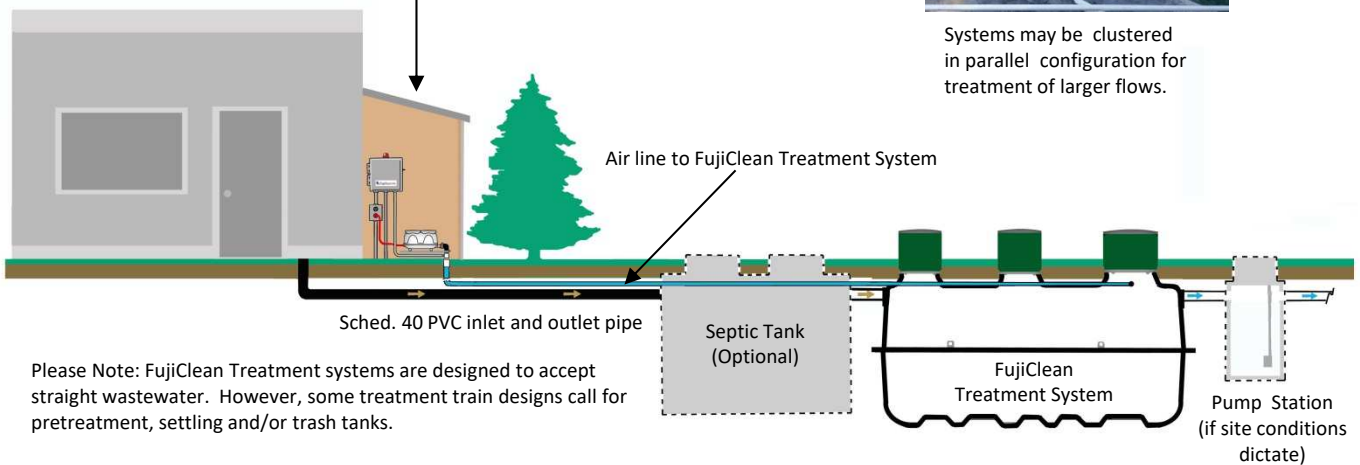

Please Note: FujiClean Treatment systems are designed to accept straight wastewater. However, some treatment train designs call for pretreatment, settling and/or trash tanks.

FujiClean commercial treatment systems are delivered plug & play ready with no onsite assembly required.



Adaptor and fittings (supplied by FujiClean USA) for connection between treatment system and FujiMAC Series "RII" Air Pump.

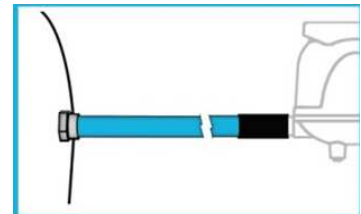

# Treatment Process Overview

FujiClean's "contact filtration" treatment is a simple, well engineered process that consists of a controlled, circuitous flow train through anaerobic and aerobic chambers and in direct contact with assorted proprietary fixed film medias on which biological digestion of organic matter occurs. Media is also designed and positioned to provide mechanical filtration of process wastewater.

The system includes two air lift pumps (see diagram below). The Recirculating Airlift Pump returns process water and sludge from the aerobic zone to the sedimentation chamber, recirculating 2-4 times inflow per day for CE models and 4-6 times inflow for CEN (enhanced denitrification) models. The Effluent Airlift Pump is designed to help equalize flow and discharge treated effluent.

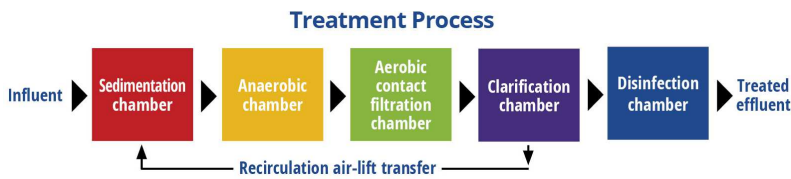

**Powered by the FujiMAC "Rll" Series Air Pumps** State-of-the-art linear diaphragm air pumps manufactured by FujiMAC, Sized to system and site conditions.

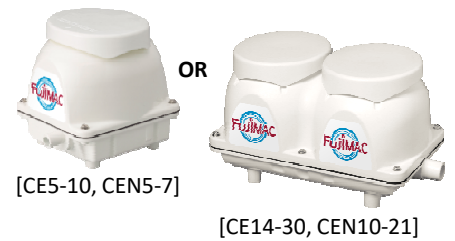

**Chamber 3B. Disinfection Chamber**  
(final zone before discharge – option for chlorination tablet disinfection)

**Chamber 3A. Clarification Chamber** (settling zone)

**Sludge Transfer**  
(Recirculating Air Lift pump back)

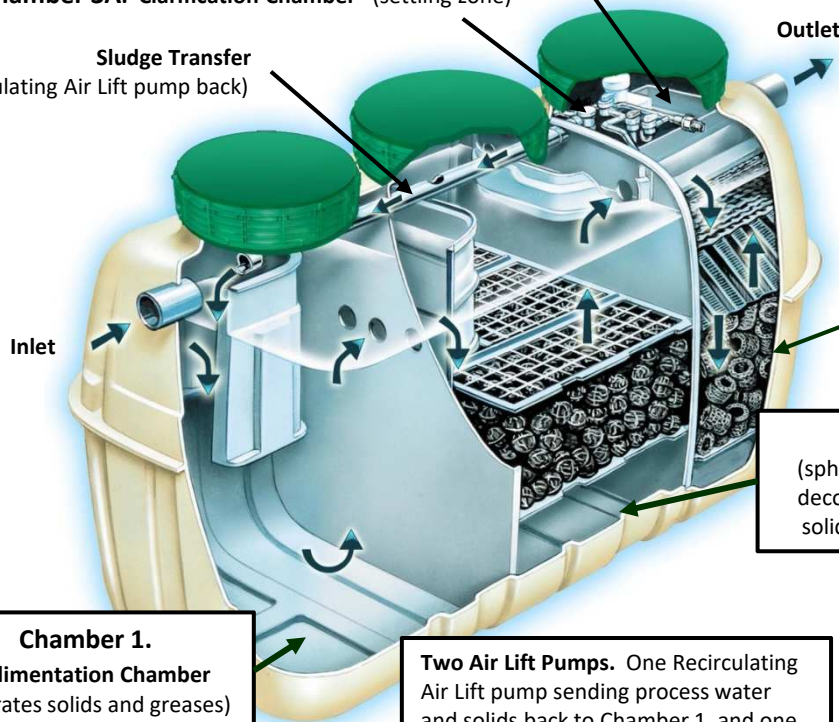

**Chamber 3. Aerobic Contact Filtration Chamber**  
(both board and cylindrical hollow mesh media) oxygen rich zone for aerobic microbe digestion activity, solids filtration and nitrification of ammoniac nitrogens to nitrates

**Chamber 2. Anaerobic Chamber**  
(spherical-skeleton filter media) organic matter decomposition by micro-organisms, suspended solids are captured and nitrates are denitrified

**Chamber 1. Sedimentation Chamber**  
(separates solids and greases)

**Two Air Lift Pumps.** One Recirculating Air Lift pump sending process water and solids back to Chamber 1, and one Effluent Air Lift pump for measured discharge of treated effluent.

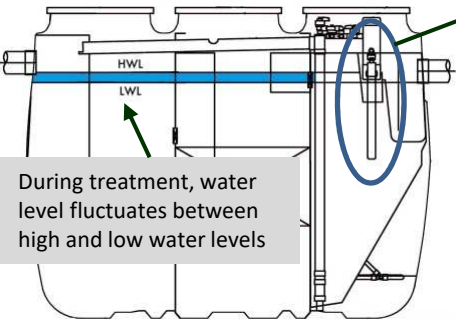

During treatment, water level fluctuates between high and low water levels

**Airlift Pumps.** This generic illustration shows the mechanics of the "airlift pumps" used in this system, which are simple pipe conduits through which pressurized air (from air pump) is introduced at the bottom and by fluid pressure, water is carried up the pipe by ascending bubbles.

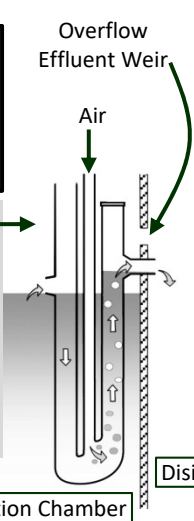

**Flow Equalization**  
When water level exceeds LWL, treated water is discharged through Chamber 3B via the Effluent Air Lift pump. If water level exceeds HWL, then treated water is also discharged through an overflow effluent weir.



## System Components and Specifications - Summary

Design Specification Table	CE Series BOD, TSS, TN*							CEN Series BOD, TSS, Enhanced TN Removal					
<b>Effluent :</b>	NSF40 NSF Test Effluent (Avg.) CBOD:11mg/L, TSS:12mg/L							NSF40/245 NSF Test Effluent (Avg.) CBOD:5mg/L, TSS:6mg/L, TN:10mg/L					
<b>Model:</b>	CE5	CE7	CE10	CE14	CE21	CE30	CE6KG	CEN5	CEN7	CEN10	CEN14	CEN21	
Load Hydraulic (GPD)	500	700	1,000	1,350	1,900	2,700	6,000	500	700	1,000	1,350	1,900	
<b>Blower Detail:</b>													
Blower Model	80RII	80RII	100RII	150RII	200RII	150RII (2)	200RII (4)	80RII	100RII	150RII	200RII	150RII (2)	
Normal Pressure (kPa)	15	15	18	20	20	20	20	15	18	20	20	20	
CFM; L/Min	2.8 80 L/MIN	2.8 80 L/MIN	3.5 CFM 100 L/MIN	5.3 CFM 150 L/MIN	7.0 CFM 200 L/MIN	11.0 CFM 300 L/MIN	28.0 CFM 800	2.8 80 L/MIN	3.5 CFM 100L/MIN	5.3 CFM 150 L/MIN	7.0 CFM 200 L/MIN	11.0 CFM 300 L/MIN	
Power Use (kWh/day)	1.2	1.2	1.7	2.7	3.7	5.4	14.8	1.2	1.7	2.7	3.7	5.4	
Weight (lbs.)	11	11	11	13	13	13 x 2	13 x 4	11	11	13	13	13 x 2	
Outlet Diameter OD-inches)	0.70	0.70	0.70	1.0	1.0	1.0 x 2	1.0 x 4	0.70	0.70	1.0	1.0	1.0 x 2	
<b>Tank Detail:</b>													
Material	Fiber-reinforced plastic							Fiber-reinforced plastic					
Height (inches)	61.8	65.4	73.2	77.4	81.3	87.2	87.2	65.4	73.2	77.4	81.3	87.2	
Length (inches)	85	95.7	98.8	118.9	152.8	183.7	434.7	95.7	98.8	118.9	152.8	183.7	
Width (inches)	43.7	49.2	56.7	68.9	72.4	78.3	115.3	49.2	56.7	68.9	72.4	78.3	
Weight (lbs.)	397	463	705	926	1,168	1,543	2,900	463	705	926	1,168	1,543	
Inlet Invert (inches)	49	53	61	62	65	71	67	53	61	62	65	71	
Outlet Invert (inches)	47	51	59	59.5	63	69	64	51	59	59.5	63	69	
Access Ports (number)	3	3	3	3	3	3	7	3	3	3	3	3	
Access Port Diameter (inches)	3@20"	2@20" 1@24"	2@20" 1@24"	2@20" 1@24"	2@20" 1@24"	2@20" 1@24"	2@20" 1@24"	4@24"x24" " " 3@24"x48" " "	2@20" 1@24"	2@20" 1@24"	2@20" 1@24"	2@20" 1@24"	2@20" 1@24"
Volume Total (gallons)	545	749	1,069	1,498	2,252	3,199	7,267	749	1,069	1,498	2,252	3,199	
* TN removal for CE systems from field testing is available. Contact FujiClean USA for details.													

\* Please consult with distributor or FujiClean USA for commercial models designed to treat hydraulic flows above those listed in this table.

\*\* Please consult with distributor or FujiClean USA for system specification and sizing in cases where influent biologic strength is greater than domestic strength.

Structural drawings of all Residential and Commercial models are available in both .dwg and pdf formats online at [www.fujicleanusa.com](http://www.fujicleanusa.com)

## Riser Installation- Step 1

FujiClean is transitioning to riser adapters on all models.



Use sharp blade to remove inner plastic ring.

Score several times on the cutting groove to remove inner ring. Use caution! Blade is sharp!

Repeat score strokes are more effective than heavy pressure.



A slipped blade can cause serious bodily injury.



A slipped blade can cut fingers.

Squeeze silicone or approved waterproof sealant into base frame groove.



20" diameter  $\phi$   
(1<sup>st</sup> and 2<sup>nd</sup> Openings and CE-5 3<sup>rd</sup> Opening)



24" diameter  $\phi$   
(3<sup>rd</sup> Opening except CE-5)

## Riser Installation-Step 2 (Tuf-Tite and Polylok)

INSTALL RISER ON ADAPTER RING.

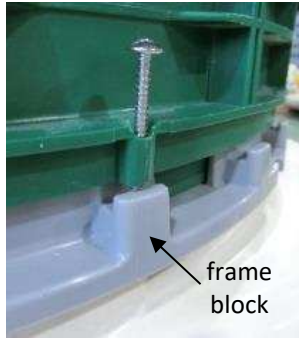

**Tuf-Tite Risers.** Align riser screw holes with molded "frame block" and screw tight. Maximum screw length is 1 ¼"

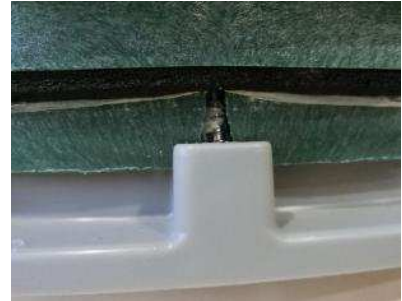
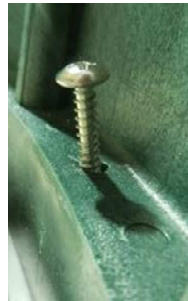
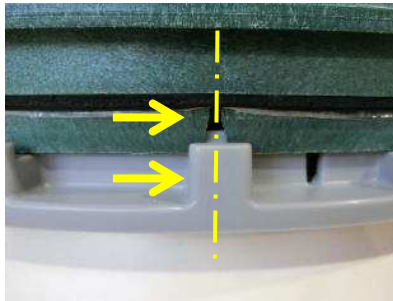

**Polylok Risers.** Align molded "frame block" with riser screw hole. Insert screw and screw tight. Maximum screw length is 1 ¼"



Apply silicone to the screw head to prevent water penetration.



## No-traffic Area Installation Procedure

### Unloading Instructions:

- ❑ Upon delivery, inspect FujiClean Treatment System, both outside and inside for possible damage incurred during transport. If you find damage, or have a question, please contact your distributor immediately.

- ❑ **Step 1: Prepare excavation to be at least 1 to 2 feet larger than the tank dimensions as listed in the Design Specification Table on page 9 of this Manual. Important Note: Total height from tank top to final grade should not exceed 24".**



- ❑ **Step 2. Prepare 4" - 6" bed of stone (1/8"), compact sand, poured or precast concrete level to within 1/8" per 2 feet. (10mm per 2 meters or 1/200).**

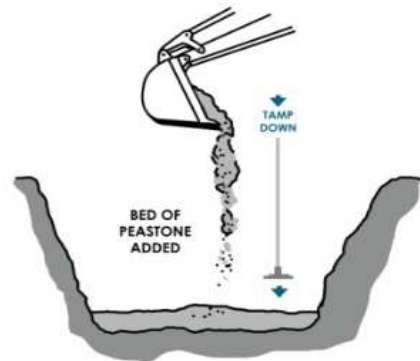

Compact stone or sand

- ❑ **Step 3: Carefully lower and set tank. Level to within 1/8" per 2 feet. (10mm per 2 meters or 1/200), both fore and aft as well as side to side.**

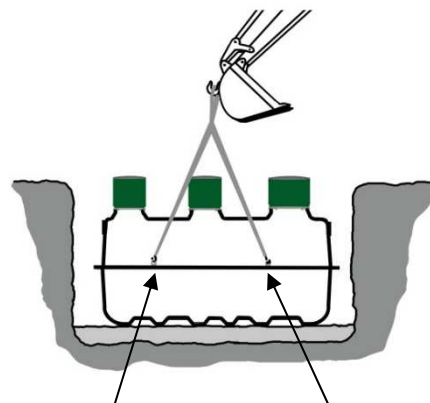

Use ALL 4-point lifting lugs

- ❑ **Step 4:** If any part of the tank is below the estimated seasonal high water table, then engineer shall provide design to assure adequate tank uplift restraint. Please contact FujiClean USA for additional information.

One technique used for uplift restraint calculations is introduced below.

### Uplift Restraint

Uplift restraint is an occasional requirement because of the many locations that experience high seasonal or tidal groundwater. Alternative uplift restraint procedures and techniques and methods are available, some more appropriate than others depending on site-specific conditions. A common technique used by engineers to calculate uplift restraint requirements is the “Soil Wedge” approach, which relies on the weight and frictional force a “soil wedge” exerts against a concrete block, is illustrated below. Designers are encouraged to consider site-specific conditions when selecting an uplift restraint procedure and technique for any specific installation.

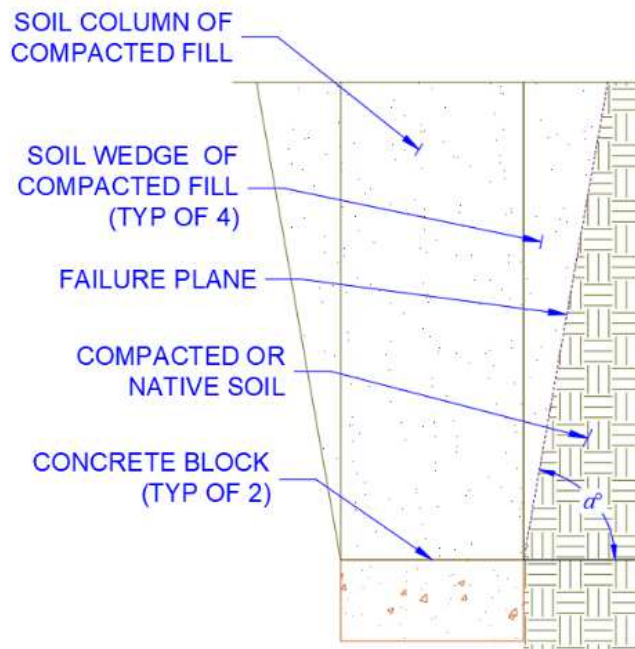

**Figure 8 - Soil Wedge Approach for Uplift Restraint**

The soil wedge approach considers that soil will exert uplift resistance against a hold-down concrete block. The magnitude of this force will consist of five components: tank weight, saturated weight of the concrete block, saturated weight of the soil column directly above the block, saturated weight of the soil wedge between the soil column and failure plane, and the frictional force along the failure plane. This approach assumes that there are no moments because opposing lateral forces will cancel themselves; only vertical forces will act on the blocks. Each is shown in the diagram.



The table below shows concrete deadman sizing calculations using the soil wedge approach for FujiClean CE and CEN models and provides the uplift restraint and factor of safety for a soil having a failure plane of 22.5° and a coefficient of friction of 0.4. The soil is cohesive, compacted to at least 95 percent Proctor density, and fully submerged. The saturated density of concrete and soil are 87.6 and 62.6 lb/ft<sup>3</sup>, respectively. The calculations include a factor of safety.

Keep in mind that uplift restraint is just one of several good practices related to maintaining long-term tank integrity. Service providers should avoid pumping tanks when groundwater conditions are unfavorable, and they should pump only sufficient liquid to complete the task. Pumped tanks should be refilled as quickly as possible.

DEADMAN CAPACITY USING SIMPLIFIED SOIL COLUMN APPROACH USING IDENTIFIED FACTORS				
MODEL	DEADMEN (EA)	DEADMAN DIMENSIONS	NET RESTRAINT PROVIDED (LBS)	FACTOR OF SAFETY
CEN5/CE5/CE7	2	8' X 18" X 8"	22,200	3.01
CEN7/CE10	2	8' X 18" X 8"	26,232	2.60
CEN10/CE14	2	8' X 18" X 8"	29,320	2.00
CEN14/CE21	2	10' X 18" X 8"	39,065	1.81
CEN21/CE30	2	12' X 18" X 8"	51,235	1.75

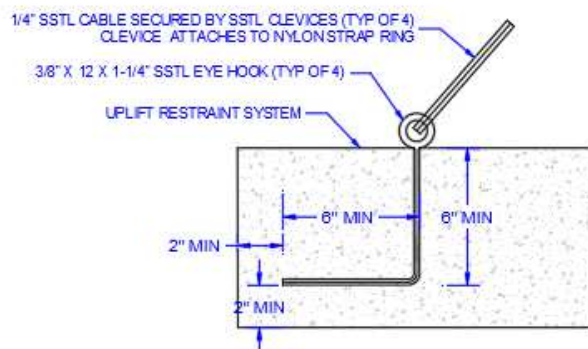
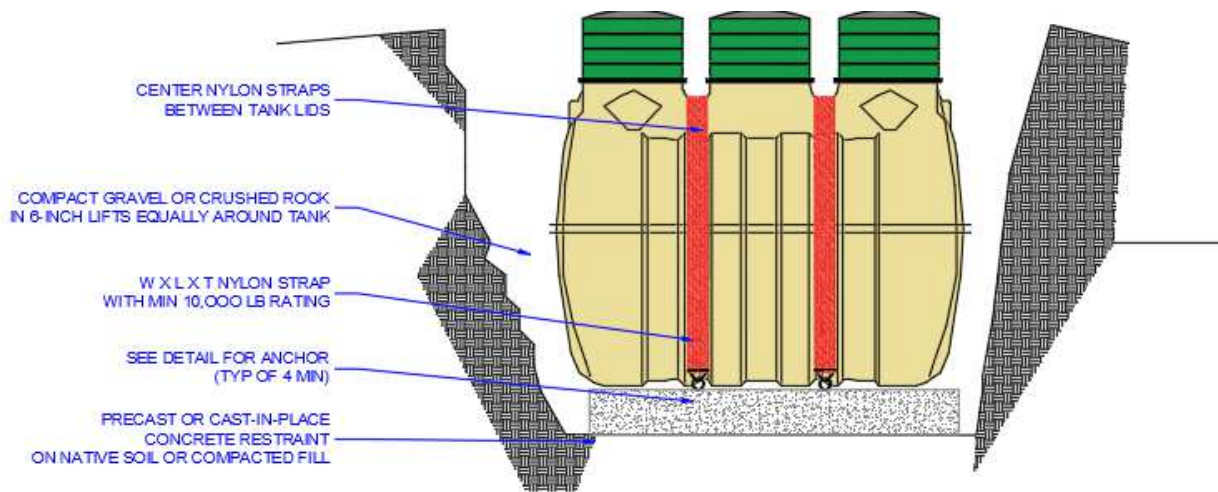

- Step 5: Fill tank with fresh water to the low water line in ALL 3 chambers.  
 Note: Start with center chamber and alternate chambers while filling for evenly balanced fill. Recheck that tank is level to 1/8" per 2 feet (10mm per 2 meter or 1/200), (fore and aft as well as side to side), as tank balance may have been altered after it is filled with water.

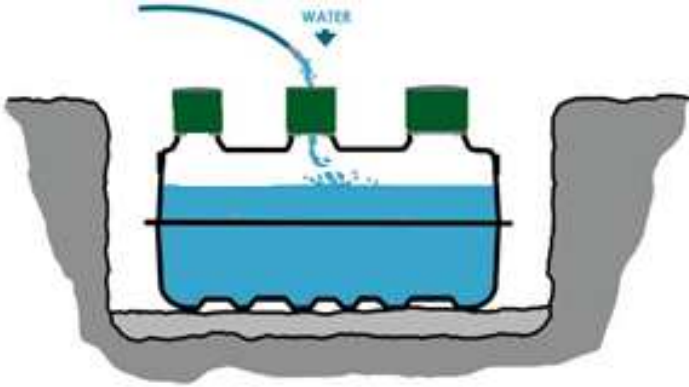

Use high/low water level decal as water marker

Please note: To ensure tank water tightness, check in 24 hours to be sure that the water level has not dropped. Contact your distributor or FujiClean USA if water level has dropped.

- Step 6: Backfill about 3/4 way up tank in layered, compacted 6" lifts using sand, stone dust, peastone or equivalent material that form-fits into tank corrugations. Keep backfill material damp to assure compact backfill and reduce settling risk. Do not use backfill material that contains rocks.

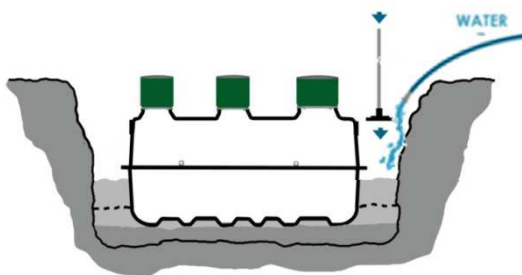

- Step 6 continued: Install inlet and outlet pipes using primer and cement. For commercial systems with 5" inlet and outlets, you may use 5": 4" eccentric reducer adapters included with system. (Note: CE14 units have 4" inlets and outlets). Install adapters with thin edge down. Apply primer and cement to 4" PVC pipe sections to inlet and outlet.

Commercial

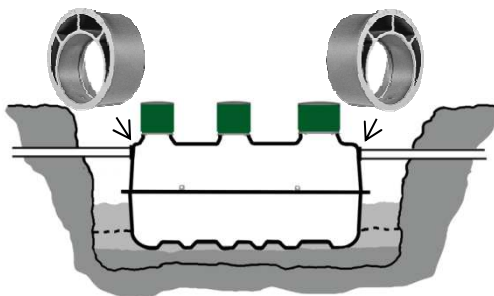

❑ **Step 7: Refer to the table below to size air line conduit. Set conduit in prepared trench (min. 6" deep) from tank to air pump.**

Air Line Conduit Diameter Table. (For conduit runs with fewer than 5 elbows)					
FujiClean Model/ Air Pump Size	CE5, CE7 CEN5 / FujiMAC 80RII	CE10, CEN7 / FujiMAC 100RII	CE14, CEN10 / FujiMAC 150RII	CE21, CEN14 / FujiMAC 200RII	CE30, CEN21 / FujiMAC 150RII (2)
Air Pump to Tank Distance					
<33 feet	3/4"	3/4"	3/4"	3/4"	1"
<100 feet	1"	1"	1"	1"	1"

※ If site conditions prevent these parameters from being followed, please consult with FujiClean USA for possible air pump upsize.

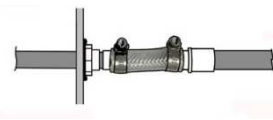
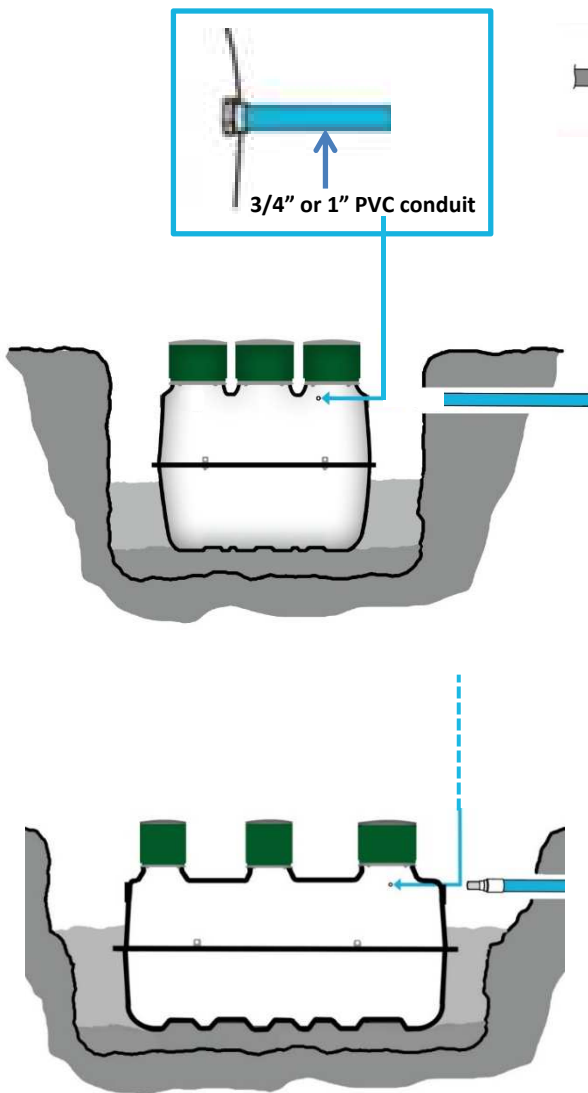

Note: Some states and contractors require a flexible air line adaptor as shown. (adaptors supplied by FujiClean USA)

**Air Line Connection to Air Pump(s) – Commercial System Examples**

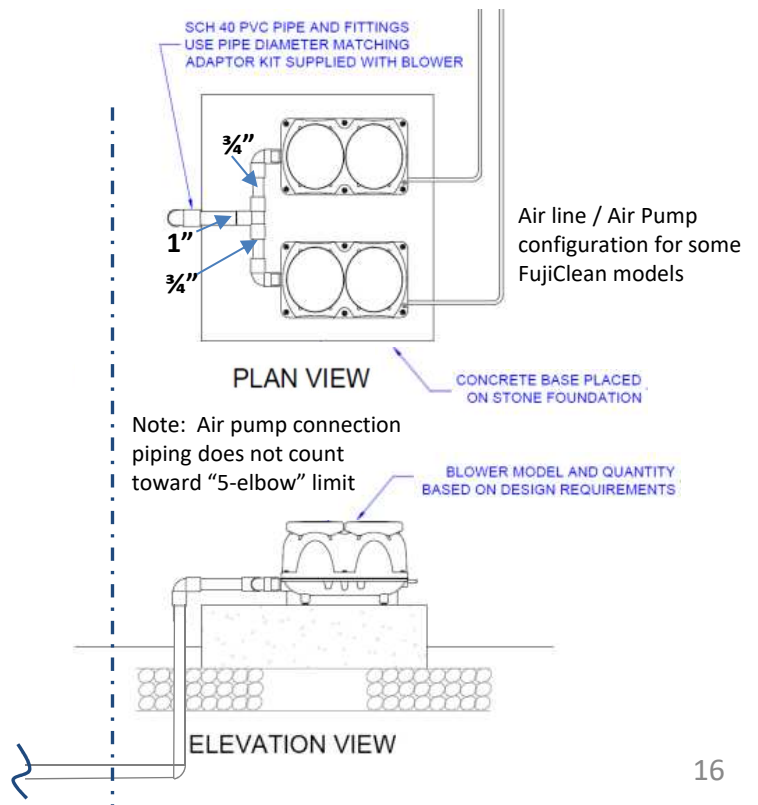

- ❑ **Step 7 continued: Set risers on the tank as necessary. Maximum riser height is 24-inches.**



- ❑ **Step 8: Locating and Installing Air Pump/Control Panel.**

**Air Pump shall be:**

- ✓ in as close proximity to control panel as possible
- ✓ on a solid (e.g. concrete) pad to minimize vibrations
- ✓ in a location above water level
- ✓ away from grease exhaust fans
- ✓ away from bedroom windows and other locations where operational sounds (although minimal) may be a nuisance
- ✓ in a location that allows unencumbered access for inspection and maintenance activity
- ✓ with proper electrical grounding
- ✓ with wiring and electrical connections made by a licensed electrician
- ✓ with no objects on top of electrical cord
- ✓ in a well-ventilated space out of direct sunlight and protected from elements



**Alarm/Control Panel shall be:**

- ✓ in a well ventilated area as dry and protected from elements as much as possible
- ✓ in as close of proximity to FujiMAC air pump as possible
- ✓ wired by qualified electrician
- ✓ in a location that allows unencumbered access for inspection and maintenance activity



**Residential**

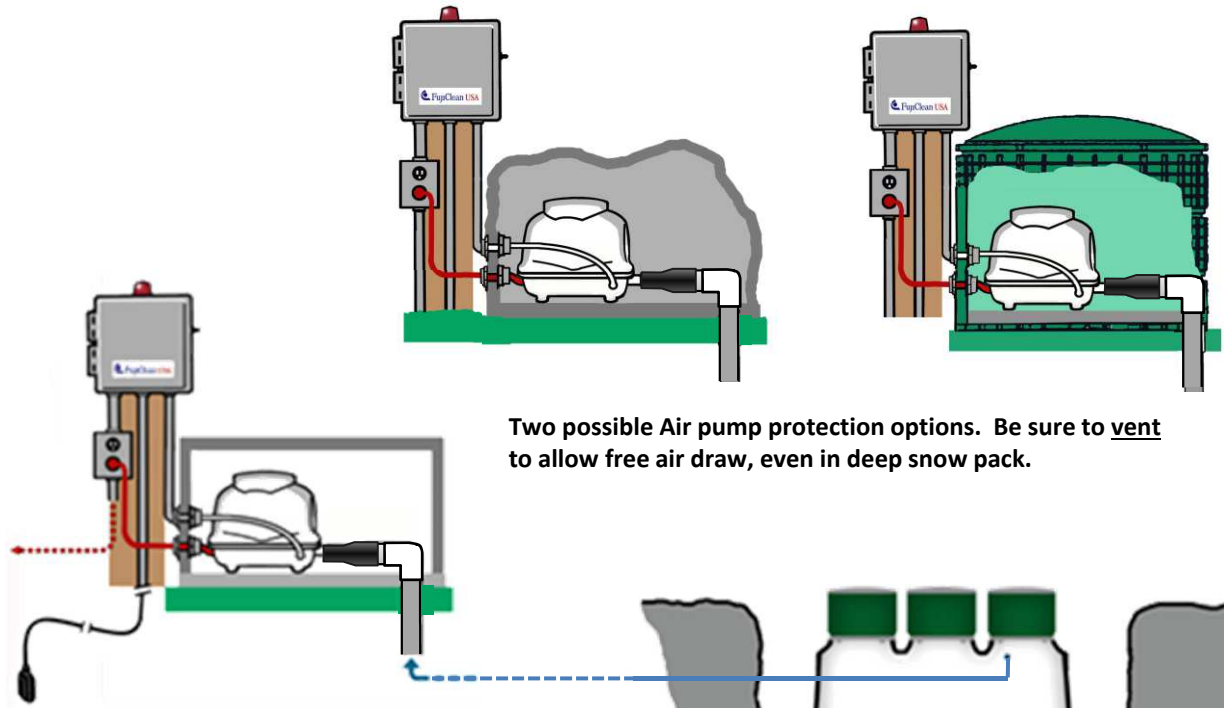

Two possible Air pump protection options. Be sure to vent to allow free air draw, even in deep snow pack.

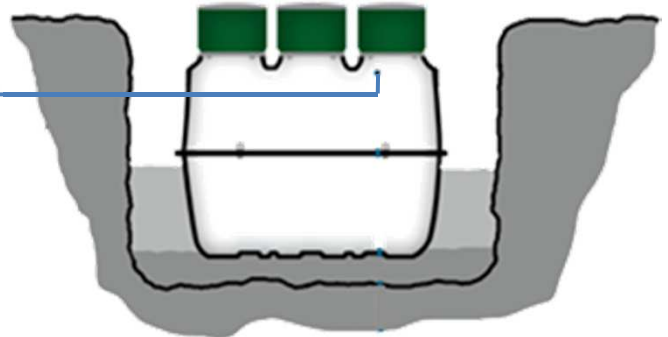

**Commercial**

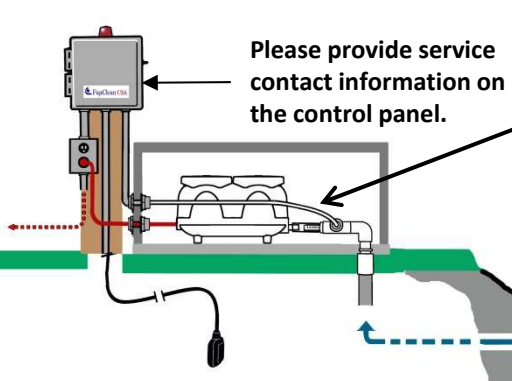

Please provide service contact information on the control panel.

Note: For some FujiClean models, including models CE30 and CEN21 (which both require two air pumps), the 1/8" (ID) Vinyl Micro-Tubing for Air Pressure Sensing Alarm is replaced with current sensing switches, supplied with the "M" panel.

Be sure to vent air pump protection cover to allow free air draw, even in deep snow pack.

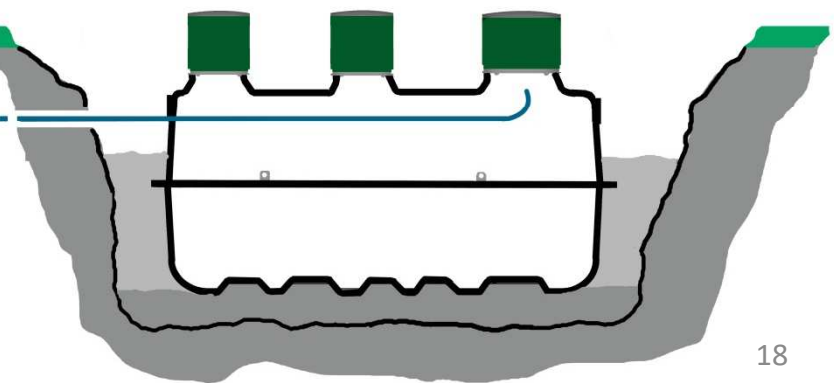



- ❑ Step 9: For cold climate installations, please install insulated riser covers and cover upper half of treatment unit with min. R-8 value insulating material (i.e. foam board).

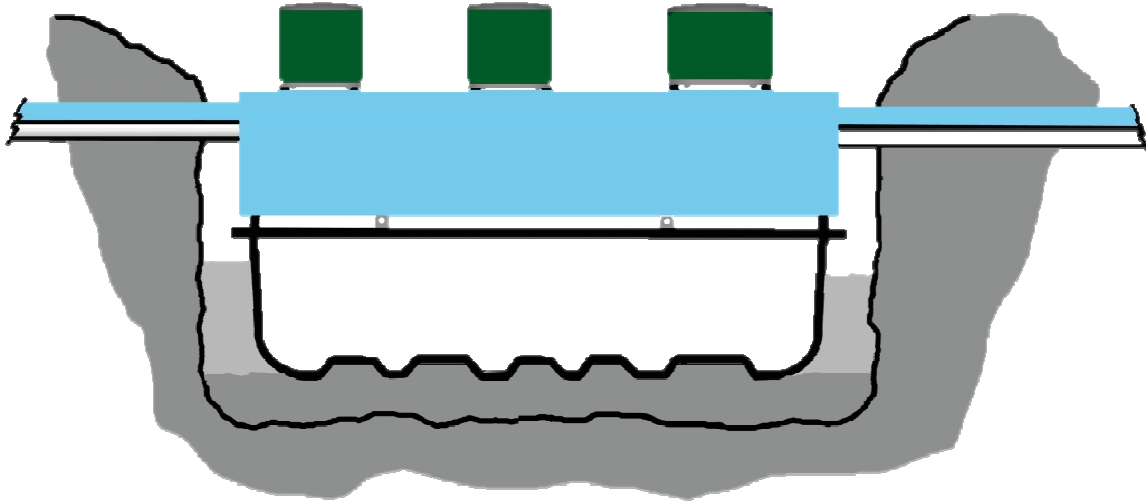

- ❑ Step 10: Connect float switch electrical cord through a male adaptor (caulked watertight to prevent septic gas leakage) or watertight fitting. An interior connection to direct burial cable is also an acceptable option.

For connection of float switch cord to alarm panel, drill hole in riser and use male fitting and electrical conduit. Plug fitting with approved sealant to assure water-tight seal and to prevent septic gas transmission into control panel.

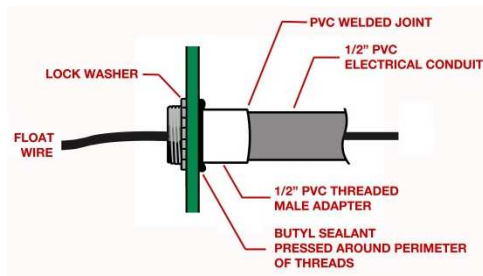

Caulk around cable in conduit to block septic air flow to control panel.



- ❑ **Step 11: The FujiClean Treatment System must be vented.** In most cases, the system will vent through the building's septic discharge pipe and building plumbing. In cases where there is a blocked air way (e.g. effluent pump), or in severe downdraft locations, a separate vent should be installed. If you install a vent, be sure that the vent pipe slopes toward the tank so that any moisture accumulation drips toward the tank.

Vent Pipe Sizing	Vent Pipe Diameter (inches)		
	Tank to Vent Distance	Residential Systems	Commercial System 1 unit
<16 feet	2" (φ50)	3" (φ75)	4" (φ100)
>16 feet	3" (φ75)	4" (φ100)	4" (φ100)

\* In cases of over 5 or more clustered units, use two (2) vent lines, each <16 feet in length.

**Residential**

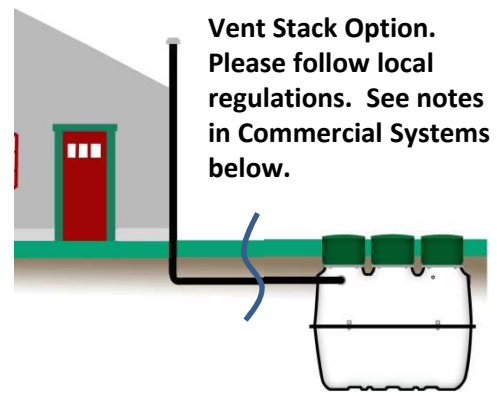
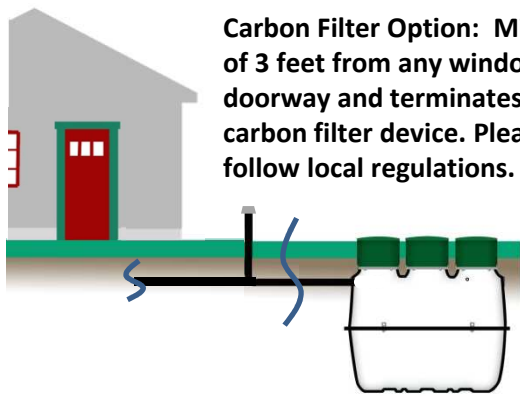

**Commercial**

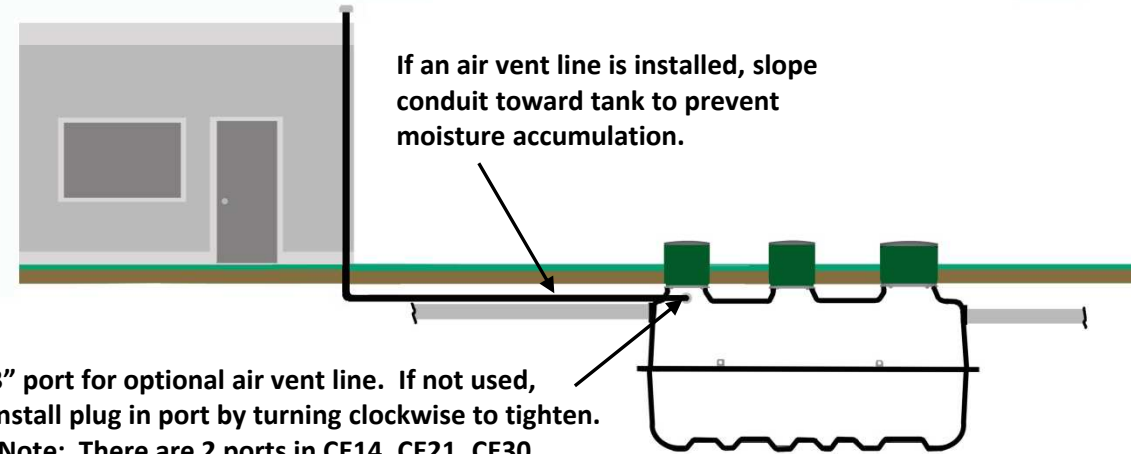

3" port for optional air vent line. If not used, install plug in port by turning clockwise to tighten. (Note: There are 2 ports in CE14, CE21, CE30, CEN14 and CEN21).

**Additional Venting Notes and Tips:**

- Local regulations may specify required vent pipe diameter
- Keep horizontal vent pipe as short as possible. Vertical pipe length should be 2 times longer than horizontal
- Installation of a positive flow ventilation fan allows for better ventilation
- Greater temperature differential between tank and outside air allows for more effective ventilation

- ❑ Step 12: During final landscaping, seeding etc., be sure to pitch final grade away from covers to sweep surface water away from the system.

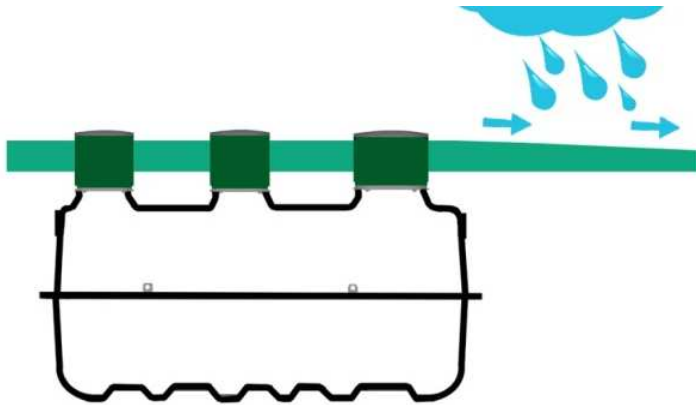
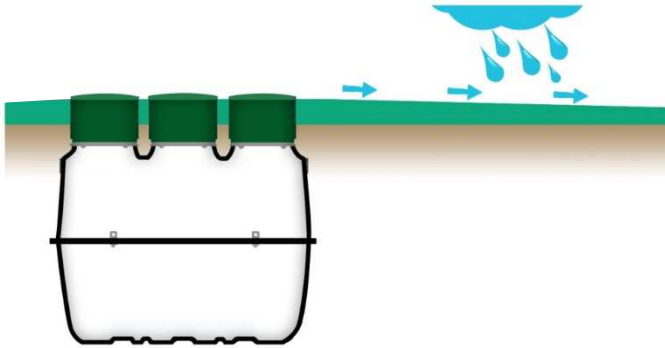

- ❑ Step 13: Fill out Warranty Activation Card (included with this Installation Manual) and return to FujiClean USA to activate system Warranty. Warranty activation is also available via [www.fujicleanusa.com](http://www.fujicleanusa.com). Please call FujiClean USA for assistance if necessary: 207-406-2927.

Please Note: Alarm/Control panel options are provided on page 39 of this Manual.

## Installation Procedure for H-20, HS-20 Using the Traffic-Rated Vault Technique

### Unloading Instructions:

- ❑ Upon delivery, inspect FujiClean Treatment System, both outside and inside for possible damage incurred during transport. If you find damage, or have a question, please contact your distributor immediately.
  
- ❑ **Required Preconditions for this Installation Technique**
  - ✓ Seasonal high groundwater depth must be less than 3'3" (1000mm).
  - ✓ Total height from ground level to adapter ring should be 24 inches or less.
  - ✓ Bearing power of soil must be 8.7 PSI or greater.

### Traffic-rated Tank / Structure

- Traffic rated precast tanks with custom cast covers are available in some markets and are typically a cost-effective option.
- Sand provides an appropriate base and support filler material.
- Traffic rated precast tanks must include drainage.
- H-20 rated drainage rings with H-20 rated covers may be used for smaller, models CE-5 to CE-14 and CEN-5 to CEN-10.

Note: Uplift restraint is required for sites where high groundwater exists. For sites without high groundwater, uplift restraint is not required. Compact soil up to tank shoulder to prevent damage if traffic-rated tank settles.

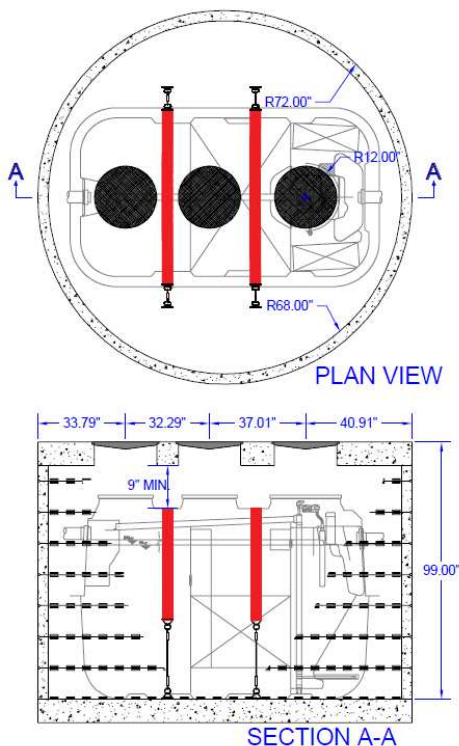

**High groundwater site**

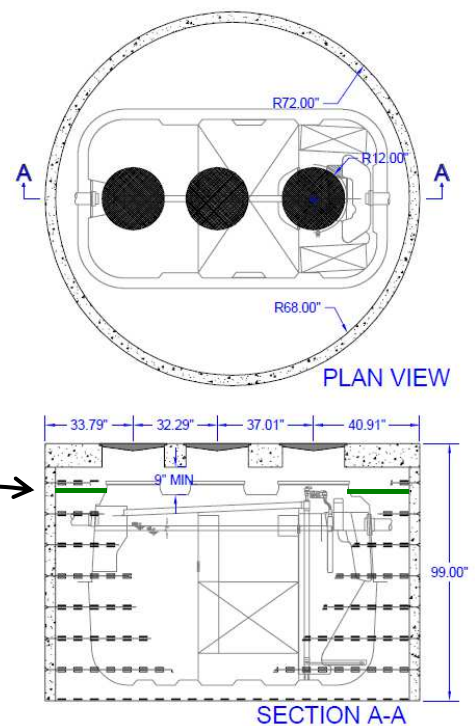

**Compact the soil up to tank shoulder.**

**Sites without high groundwater**



Drawings on the following pages illustrate some traffic rated vault options for sites requiring traffic-rated installations.

Sites requiring traffic-rated installations can also have high seasonal saturation, so vault must include drainage holes.

Vaults must include embedded hooks/eyebolts or equivalent for tie-down restraint strapping.

Note: do not use tank lifting lugs for tie-down purposes.

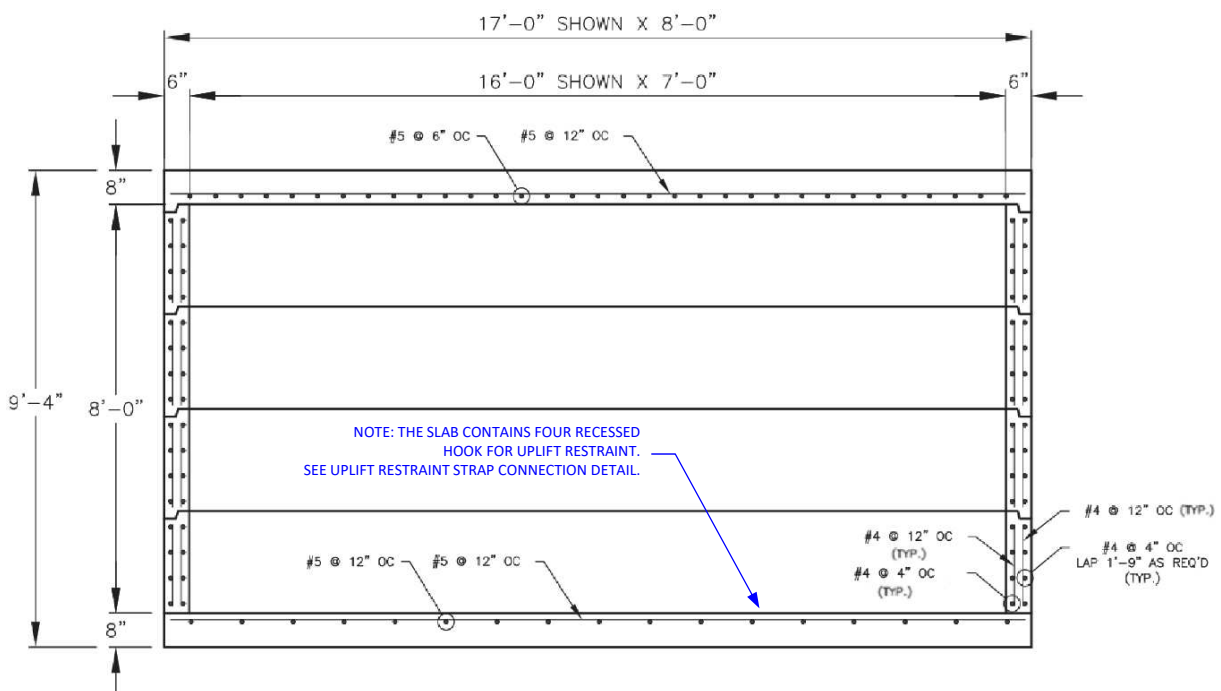
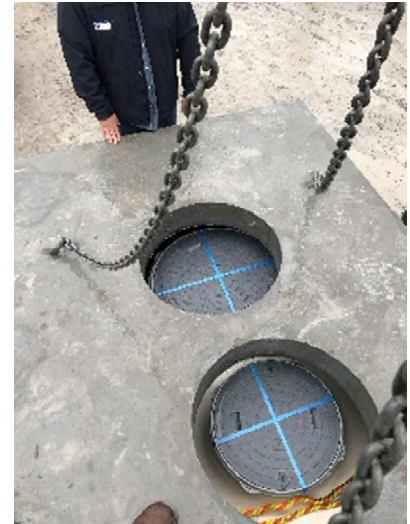
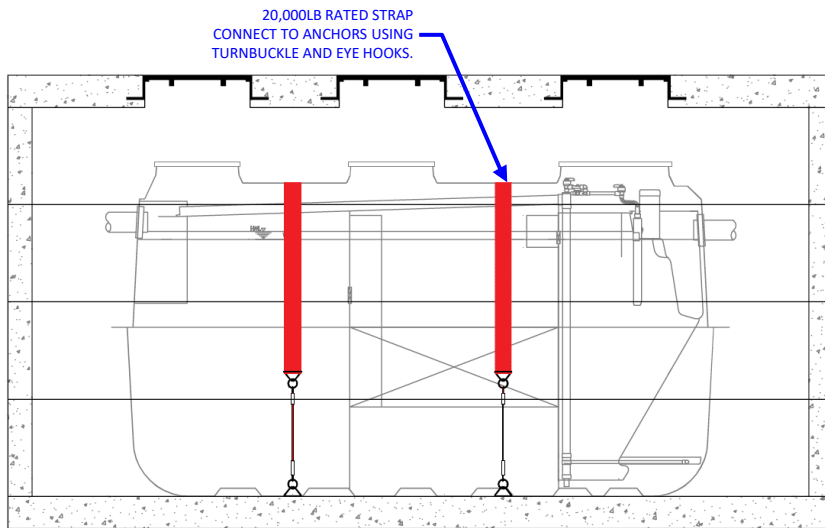



## Installation Procedure for H-20, HS-20 Using the Poured Top Slab Technique

**Note:** This technique is only acceptable for larger FujiClean models (CE14 to CE30 and CEN14 to CEN21).

**Unloading Instructions:**

- ❑ Upon delivery, inspect FujiClean Treatment System, both outside and inside for possible damage incurred during transport. If you find damage, or have a question, please contact your distributor immediately.
  
- ❑ **Required Preconditions for this Installation Technique:**
  - ✓ Seasonal high groundwater depth must be less than 3 feet 3 inches (1000mm).
  - ✓ Total height from ground level to tank adapter ring should be 24 inches.
  - ✓ Bearing power of soil must be 8.7 PSI or greater.

❑ **Step 1: Excavation**

Prepare excavation to be FujiClean treatment system dimensions as listed on page 9 and concrete slab dimensions on page 29.

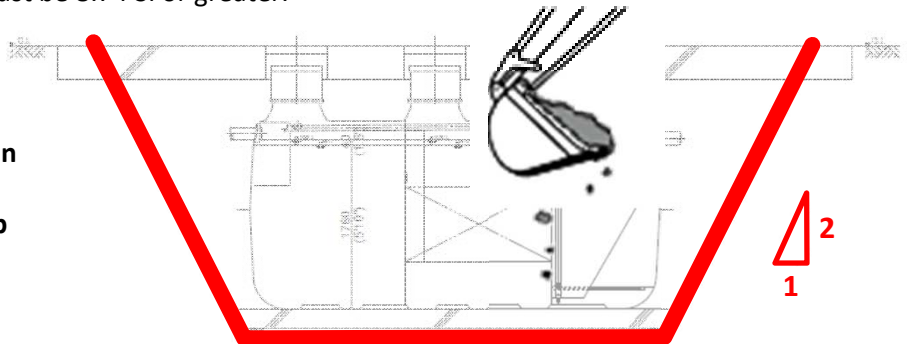

**Important Notes:**

Total height from final grade to tank adapter ring should be no greater than 24 inches.

Make sure excavation of slope has a 2:1 as a zone of influence. Install a landslide protection wall in unstable soil conditions.

❑ **Step 2: Compact stone base**

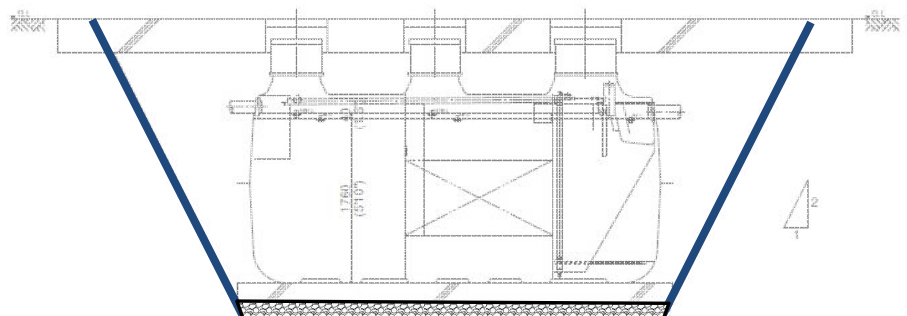

- ❑ Step 3: Set pre-cast concrete or pour concrete base.

H-20 and HS-20 load installations require a concrete base. Bearing power of soil should be 8.7 PSI or more.

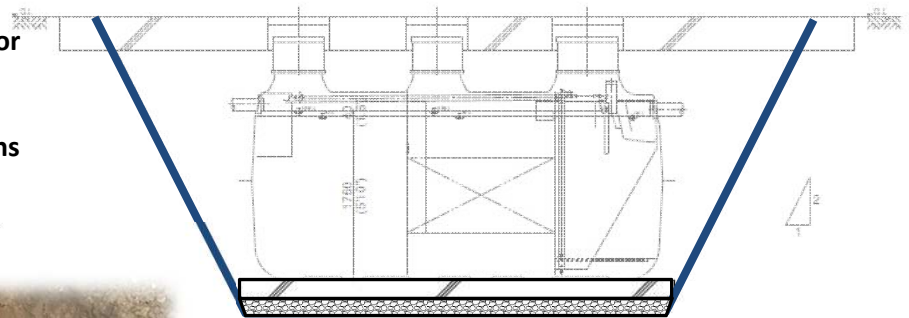

Check that concrete is level to 1/8" per 2 feet (10mm per 2 meter or 1/200), (fore and aft as well as side to side).

### Pre-cast concrete base option

- ❑ Step 4: Set tank

Use 4-point lifting lugs. Carefully lower and set tank.

Check that tank is level to 1/8" per 2 feet, (10mm per 2 meter or 1/200), fore and aft as well as side to side.

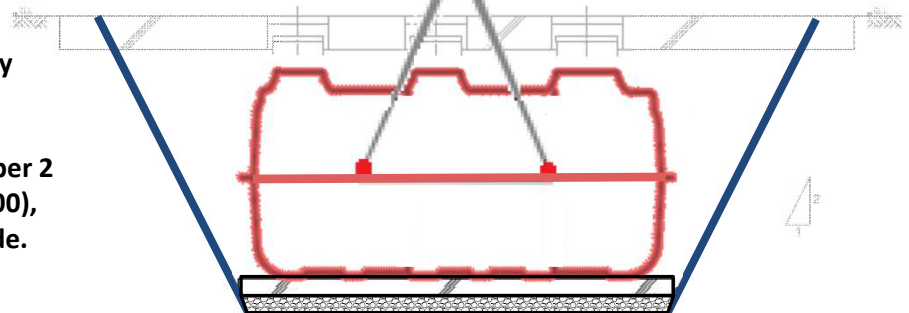

- ❑ Step 5: Fill tank with fresh water to Low water level mark in all 3 chambers.

Note: Start with center chamber and alternate chambers while filling for evenly balanced fill.

Recheck that tank is level to 1/8" per 2 feet (10mm per 2 meter or 1/200), (fore and aft as well as side to side), as tank balance might be altered after it is filled with water.

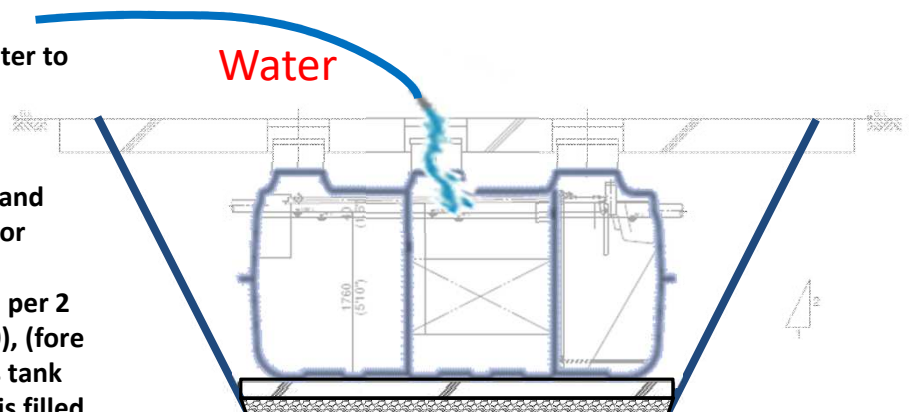

To ensure tank water tightness, check in 24 hours to be sure that the water level has not dropped. Contact your distributor or FujiClean USA if water level has dropped.

- ❑ **Step 6: Backfill about 3/4 way up tank in layered, compacted 6" lifts using sand, stone dust, pea stone or equivalent material that form-fits into tank corrugations. Keep backfill material damp to ensure compact backfill.**

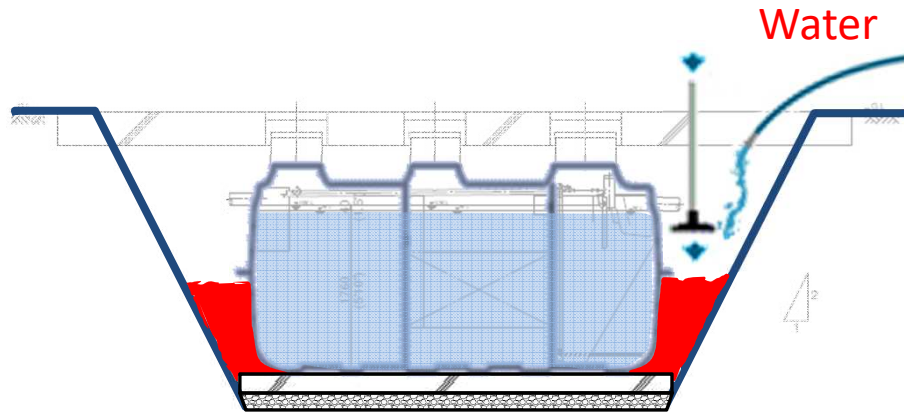

- ❑ **Step 6 continued: Install inlet and outlet pipes using primer and cement. For larger systems with 5" inlet and outlets, you may use 5": 4" eccentric reducer adapters included with system.(Except CE14) Install with thin edge down. Apply primer and cement to 4" PVC pipe sections to inlet and outlet.**

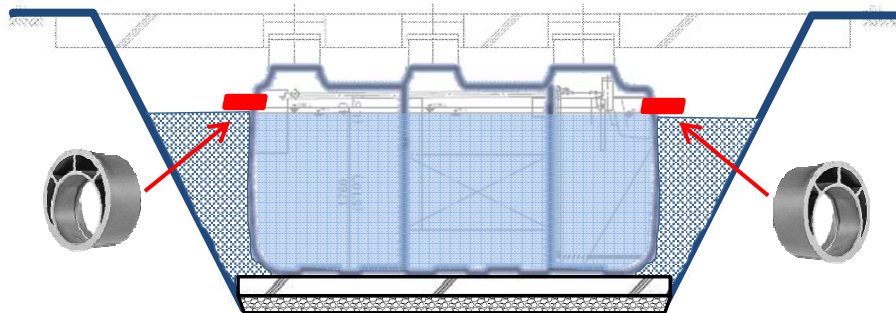

- ❑ **Step 7: Connect 3/4" or 1" air line conduit. Please refer to table below for sizing. Please refer page 17 for air pump location detail.**

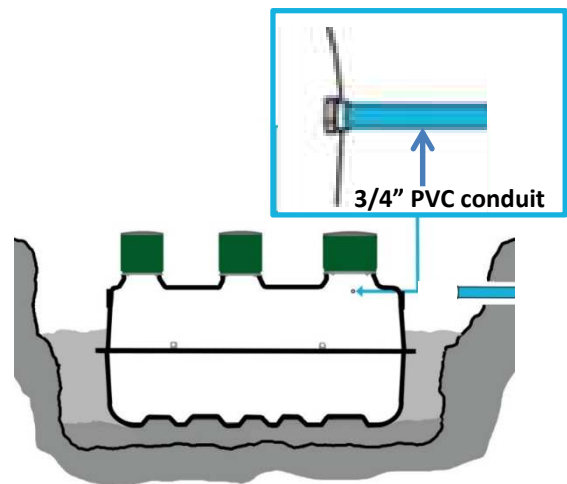
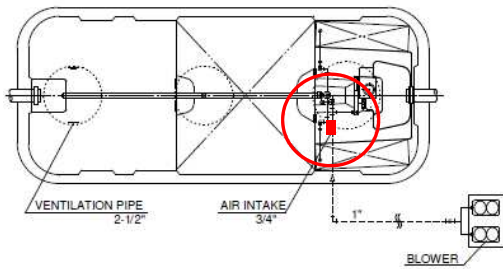
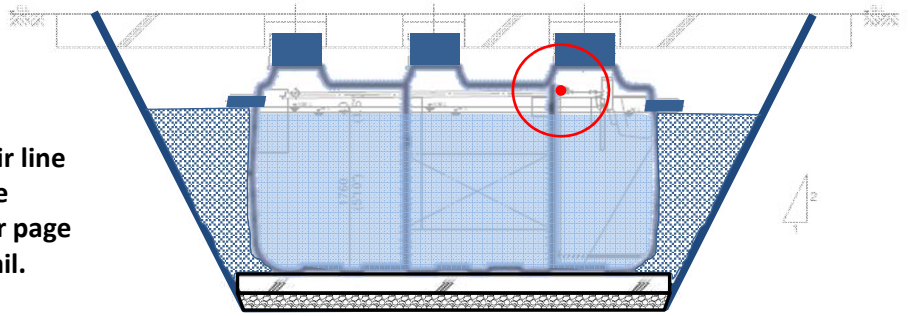

Air Line Conduit Diameter Table. (For conduit runs with fewer than 5 elbows)			
FujiClean Model/ Air Pump Size	CE14 / FujiMAC 150RII	CE21, CEN14 / FujiMAC 200RII	CE30, CEN21 / FujiMAC 150RII (2)
Air Pump to Tank Distance			
<33 feet	3/4"	3/4"	1"
<100 feet	1"	1"	1"

- ❑ **Step 7 continued: Set and secure risers to tank.**
- ❑ **Step 8: Locate and Install Air Pump/Control Panel. Please refer the details page 17-18.**
- ❑ **Step 9: Install float switch electrical cord. Connect through a male adaptor (caulked watertight to prevent septic gas leakage) or watertight fitting. An interior connection to direct burial cable is also an acceptable option. See details on page 19.**

- ❑ **Step 10:** The FujiClean Treatment System must be vented. In most cases, the system will vent through the building's septic discharge pipe and building plumbing. In cases where there is a blocked air way (e.g. effluent pump), or in severe downdraft locations, a separate vent should be installed. If you install a vent, be sure that the vent pipe slopes toward the tank so that any moisture accumulation drips back down toward the tank.

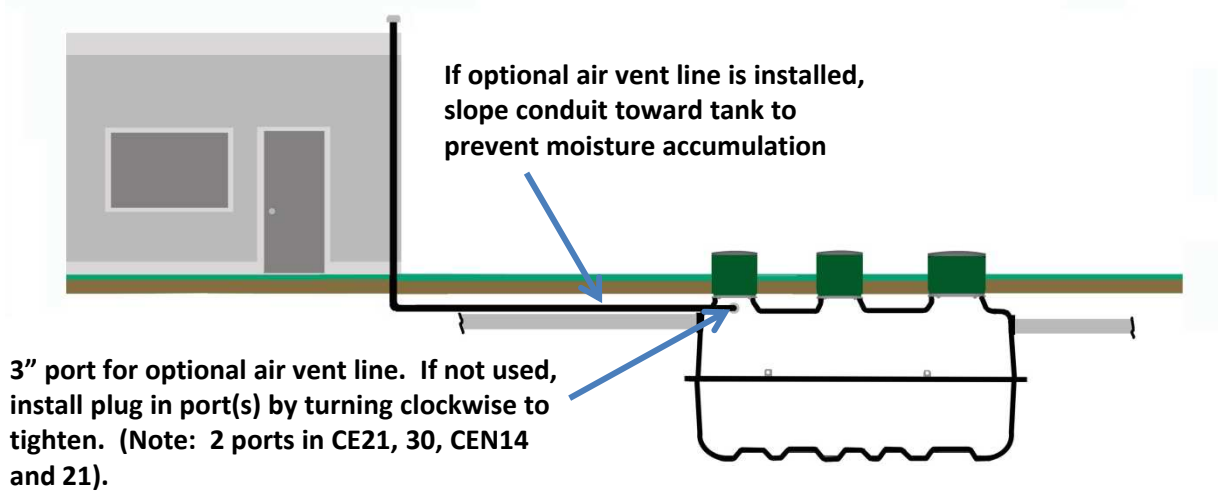

Vent Pipe Sizing	Vent Pipe Diameter (inches)		
	Residential Systems	Commercial System 1 unit	Commercial Systems 2-4 Clustered Units*
Tank to Vent Distance			
<16 feet	2" (φ50)	3" (φ75)	4" (φ100)
>16 feet	3" (φ75)	4" (φ100)	4" (φ100)

\* In cases of over 5 or more clustered units, use two (2) vent lines, each <16 feet in length.

**Additional Venting Notes and Tips:**

- Local regulations may specify required vent pipe diameter
- Keep horizontal vent pipe as short as possible. Vertical pipe length should be 2 times longer than horizontal
- Installation of a positive flow ventilation fan allows for better ventilation
- Greater temperature differential between tank and outside air allows for more effective ventilation

- ❑ **Step 11:** Backfill up to slab base. Compact tightly. Keep backfill material damp to ensure compact backfill and to reduce settling risk.

**Note:** Bearing power of soil under slab should be 4.4 PSI or more.

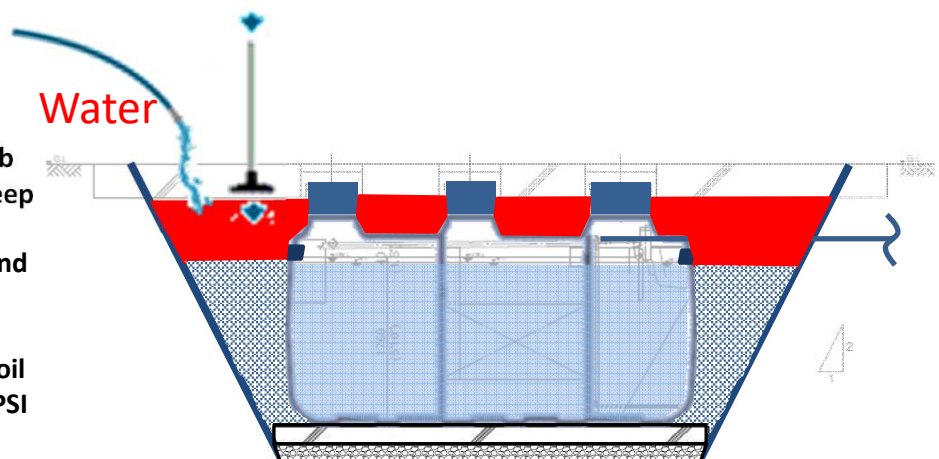



- Step 12: Set cast iron access covers and rebar arrangement for top slab. (see rebar specifications in table below).

Pour slab based on dimensions outlined below.

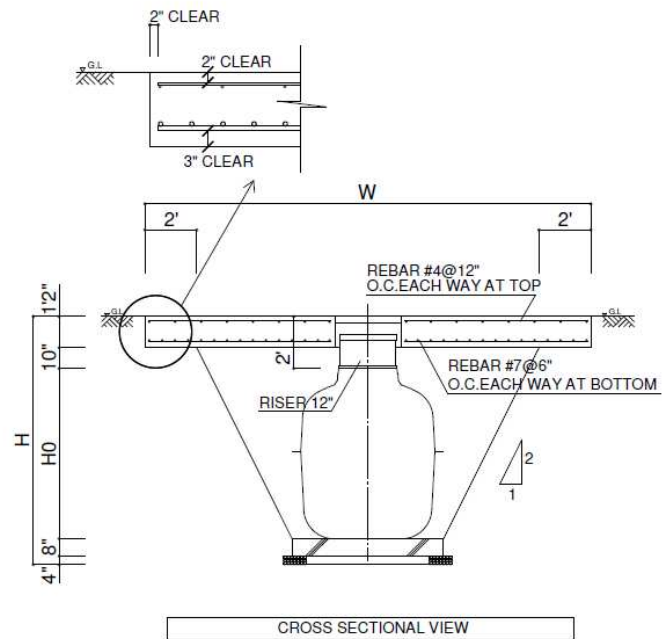
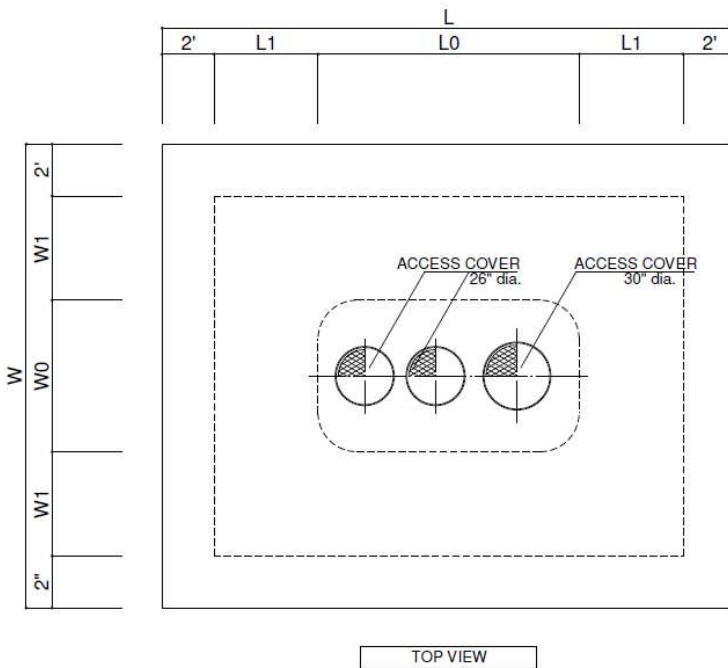
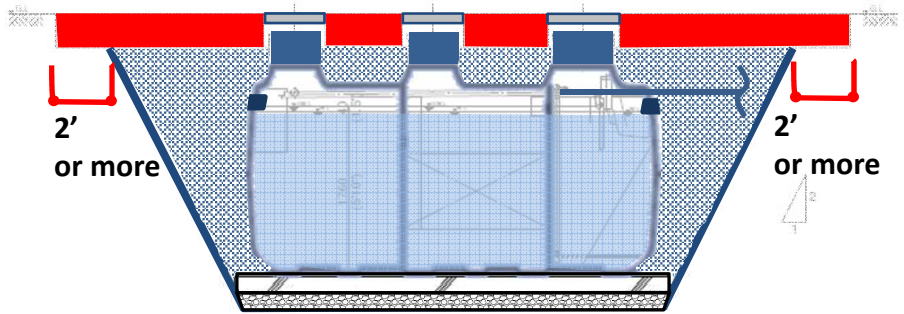

**\*Dimensions**

	CE14	CE21,CEN14	CE30,CEN21
L	21'1"	24'3"	27'4"
L0	9'11"	12'9"	15'4"
L1, W1	3'7"	3'10"	4'
W	17'	17'6"	18'6"
W0	5'9"	6'	6'6"
H	9'5"	9'9"	10'3"
H0	6'5"	6'9"	7'3"

SPECIFICATIONS
✓ CONCRETE STRENGTH: F'c= 4500PSI, MIN.
✓ STEEL WIRE : ASTM A615, GRADE 60 NEW DEFORMED BARS.

**\*Rebar specifications**

		CE14	CE21,CEN14	CE30,CEN21
Slab t: 1'2"	Top reinforcing	#4@12-inches O.C.Each way		
	Bottom reinforcing	#7@6-inches O.C.Each way		
Base	Pre-cast concrete	Thickness: 8"		

- ❑ Step 12 continued:  
Concrete work

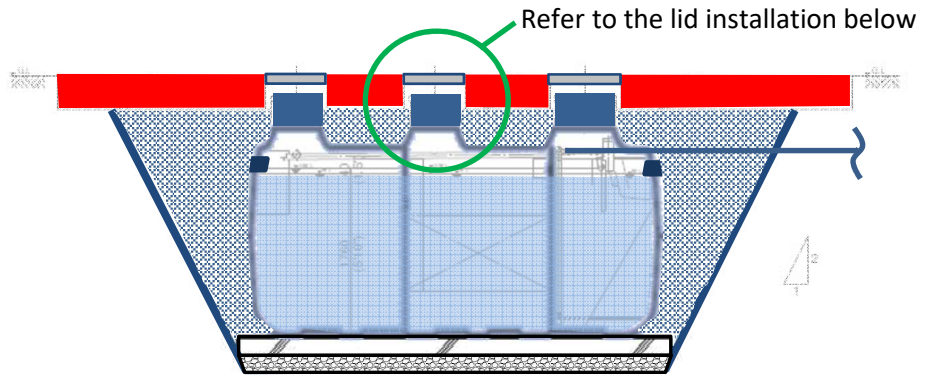

- ❑ Step 12 continued : Allow concrete to cure with cast iron access covers inserts until hardened.

**REFERENCE FOR SETTING CAST IRON ACCESS COVER**

Cast Iron Access cover	Tuf-Tite Riser / Polylok Riser
26"	20"
30"	24"

Reference drawing for how to set access covers.

Concrete slab and tank must be separated to prevent a direct load on tank.

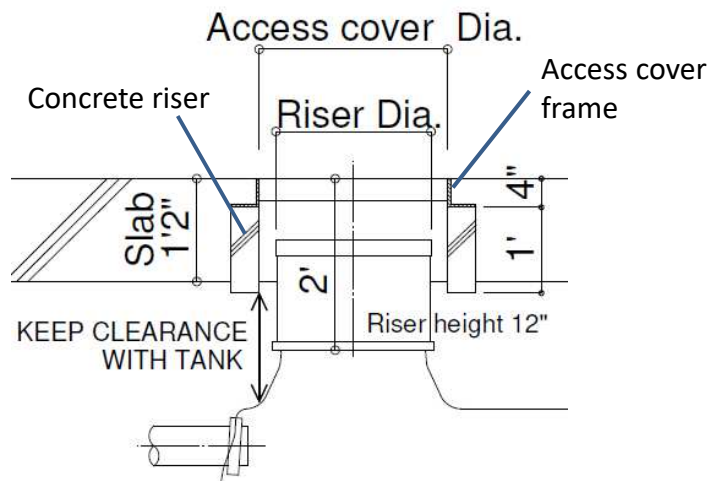

- ❑ Step 13: Be sure to pitch final grade away from covers to sweep surface water away from system.

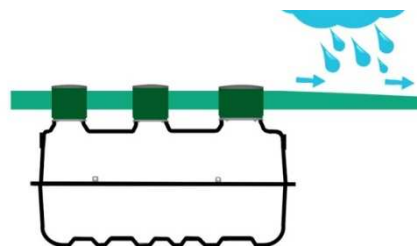

- ❑ Step 14: Fill out Warranty Activation Card (received with this Installation Manual) and return to FujiClean USA to activate system Warranty. Warranty activation is also available via [www.fujicleanusa.com](http://www.fujicleanusa.com). Please call FujiClean USA for assistance if necessary: 207-406-2927.

Please Note: Alarm/Control panel options are provided on page 39.

**Installation Procedure for H-20, HS-20 Using the Support Column Technique**

**Unloading Instructions:**

- ❑ Upon delivery, inspect FujiClean Treatment System, both outside and inside for possible damage incurred during transport. If you find damage, or have a question, please contact your distributor immediately.
- ❑ **Required Preconditions for this Installation Technique**
  - ✓ Seasonal high groundwater depth must be less than 3 feet 3 inches (1000mm).
  - ✓ Maximum riser height is 24 inches.
  - ✓ Bearing power of soil must be 8.7 PSI or greater.

❑ **Step 1: Excavation**

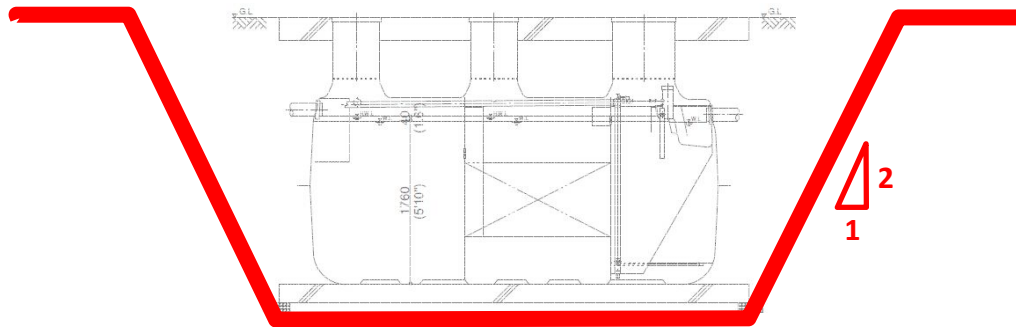

❑ **Step 2: Compact stone base**

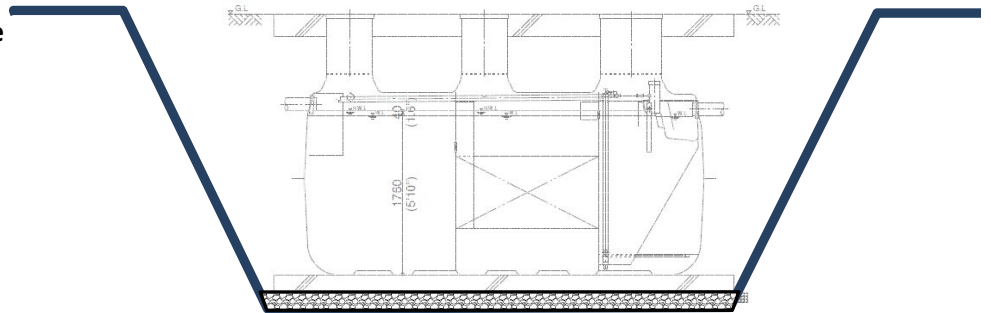

❑ **Step 3: Set pre-cast concrete or pour concrete base.**

H-20 and HS-20 load require concrete base. Bearing power of soil should be 8.7 PSI or more.

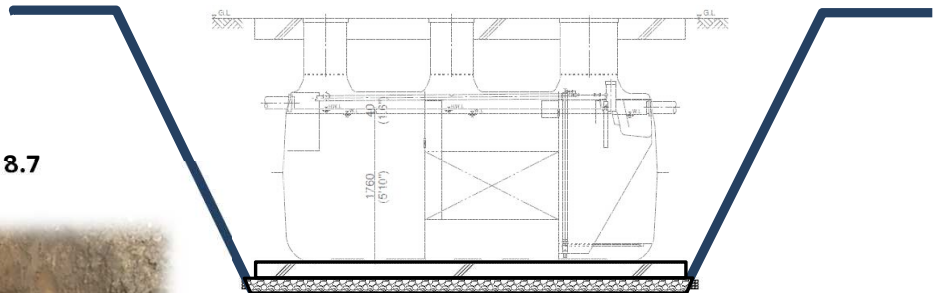

Check the concrete is level to 1/8" per 2 feet (10mm per 2 meter or 1/200), (fore and aft as well as side to side).

**Pre-cast concrete base option**

- ❑ Step 4: Check drawings for location of columns. Set column anchoring rebar support as shown below.

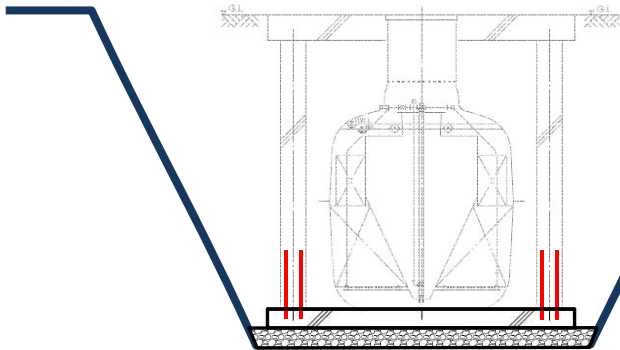

Adhesive anchoring installation structure

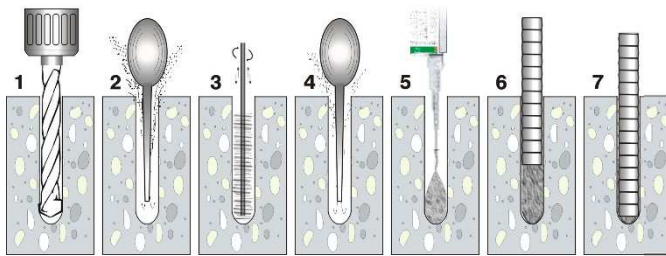

Rebar with Adhesive

- ❑ Step 4 continued: Affix spiral or square rebar frame to each support anchor. Cover each structure with 10" Sonotube or PVC pipe.

Spiral rebar frame

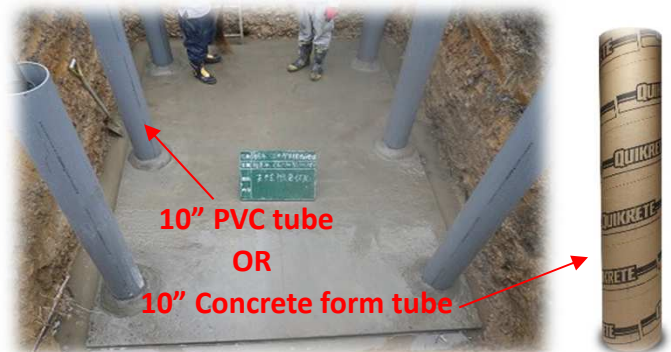
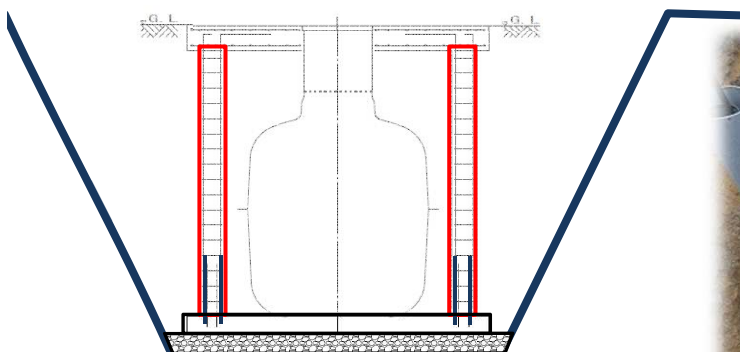

- ❑ Step 4 continued: Pour concrete into each tube.



❑ Step 5: Set tank

Note: It is acceptable to set tank before setting and pouring concrete columns.

Check tank is level to 1/8" per 2 feet, (10mm per 2 meter or 1/200), fore and aft as well as side to side.

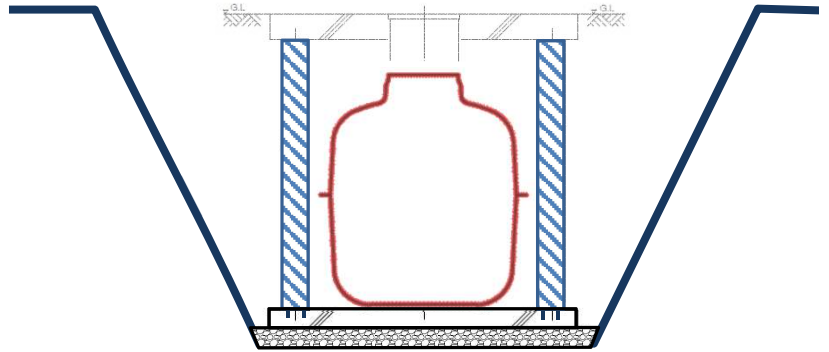

❑ Step 6: Fill tank with fresh water to Low Water Level (LWL) mark in all 3 chambers.

Note: Start with center chamber and alternate chambers while filling for evenly balanced fill. Recheck that tank is level to 1/8" per 2 feet (10mm per 2 meter or 1/200), (fore and aft as well as side to side), as tank balance might be altered after it is filled with water.

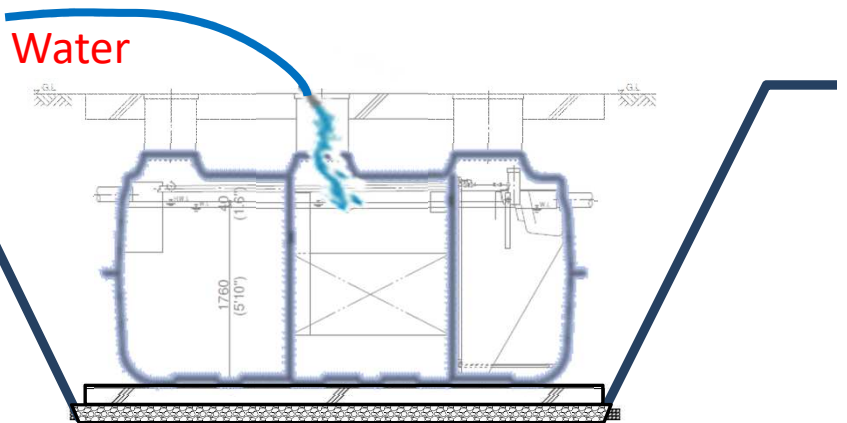

Please note: To ensure tank water tightness, check in 24 hours to be sure that the water level has not dropped. Contact your distributor or FujiClean USA if water level has dropped.

❑ Step 7: After concrete is hardened on support columns, backfill about 3/4 way up tank in layered, compacted 6" lifts using sand, stone dust, pea stone or equivalent material that form-fits into tank corrugations. Keep backfill material damp to assure compact backfill.

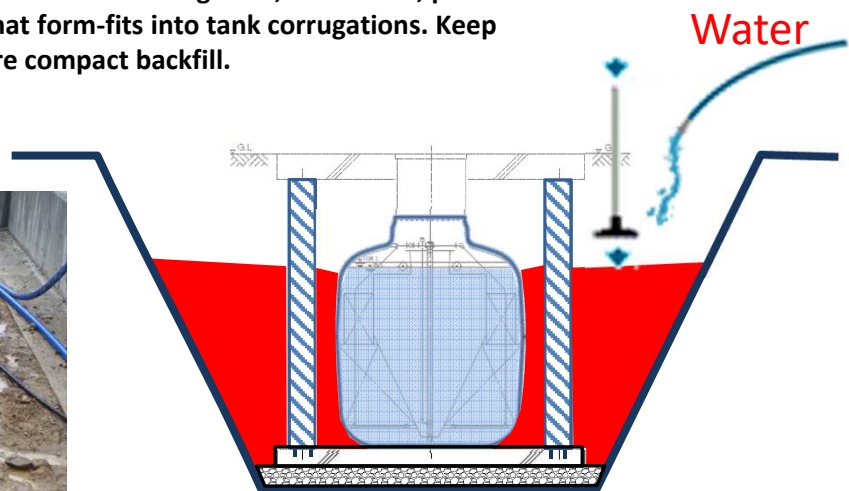



- ❑ Step 7 continued: Install inlet and outlet pipes. 5": 4" eccentric reducer adapters are provided by Fuji Clean USA if required. More details on page 15.

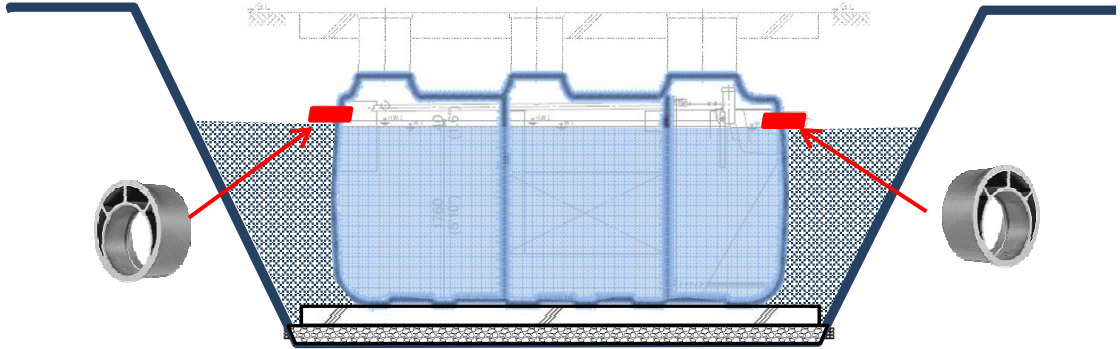

- ❑ Step 8: Connect 3/4" or 1" air line conduit. Please refer to table on page 16 for air line conduit sizing. Please refer page 17 for air pump location detail.

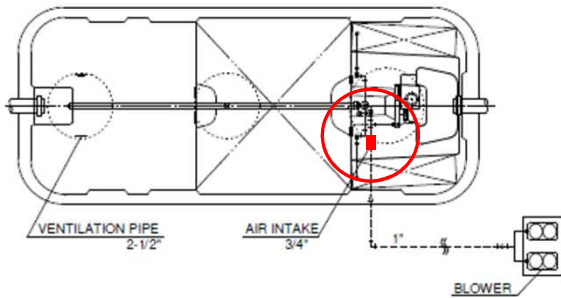

For connection air line to tank, use approved sealant to prevent septic gas transmission into control panel.

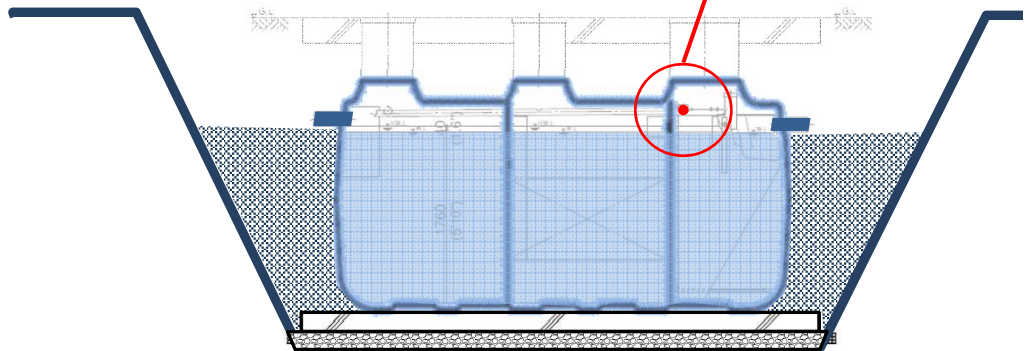
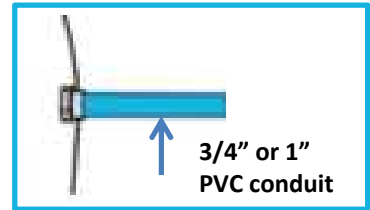

- ❑ Step 8 continued: Set riser on the tank. Maximum riser height is 24-inches.
- ❑ Step 9: Locating and Installing Air Pump/Control Panel. Please refer to instructions on page 17-18.

- ❑ **Step 10:** For cold climate installations, please install insulated riser access covers and cover upper half of treatment unit with min. R-8 value insulating material (i.e. foam board).

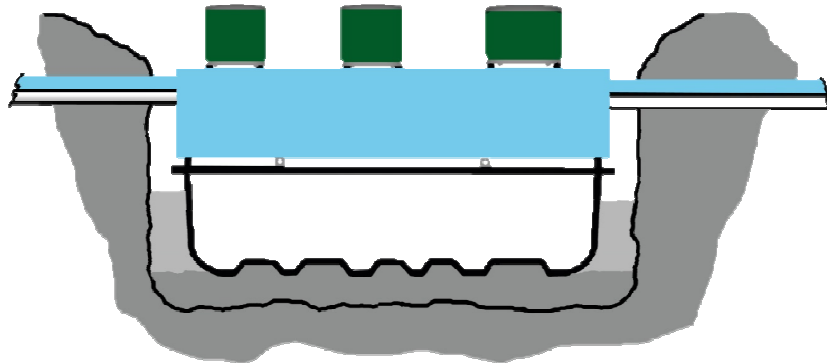

- ❑ **Step 11:** Connect float switch electrical cord through exit riser wall with a male adaptor (caulked watertight to prevent septic gas leakage) or watertight fitting. An interior connection to direct burial cable is also an acceptable option.

For connection of float switch cord to alarm panel, drill hole in riser and use male fitting and electrical conduit. Plug fitting with approved sealant to ensure water-tight seal and to prevent septic gas transmission into control panel.

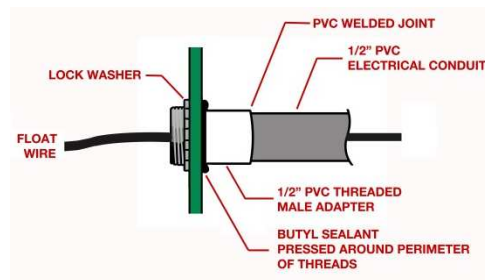

- ❑ **Step 12:** If a separate air vent is necessary, please refer to instructions on page 20.

- ❑ **Step 13:** Backfill up to base of top slab. Make sure to compact tightly.

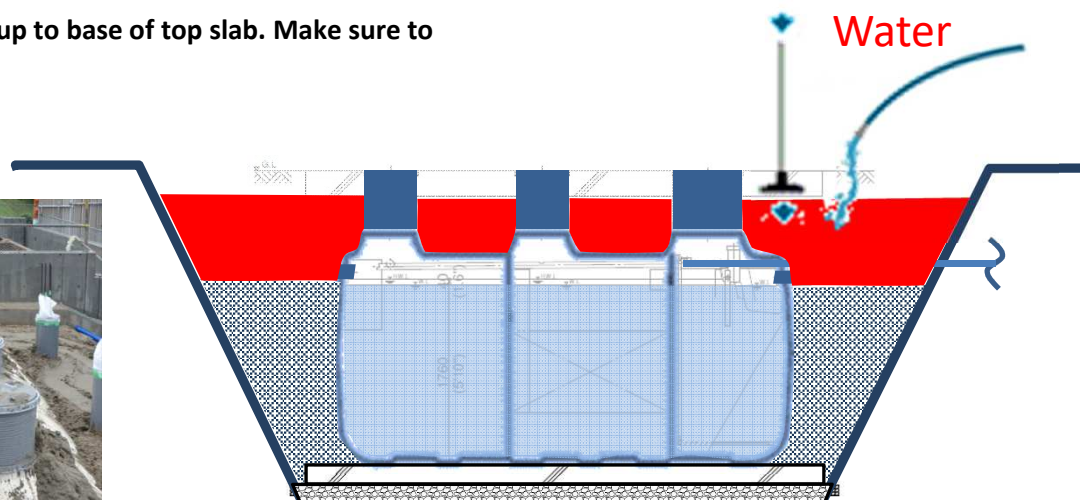

- Step 14: Set cast iron access covers and rebar arrangement for top slab. (rebar and cast iron access covers specifications in table below and following 3 pages.)  
Pour slab based on dimensions outlined below.

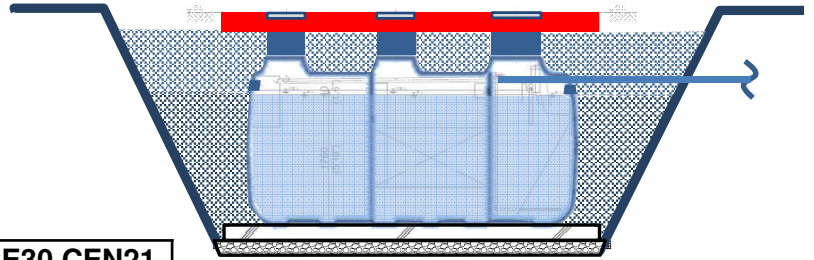

DIMENSIONS:

	CE14	CE21,CEN14	CE30,CEN21
L	11'3"	14'1"	16'8"
L0	9'11"	12'9"	15'4"
L1	4'3"	5'8"	7'
L2	4'3"	5'8"	7'
W	9'	9'4"	9'10"
W0	5'9"	6'	6'6"
W1	7'5"	7'8"	8'2"

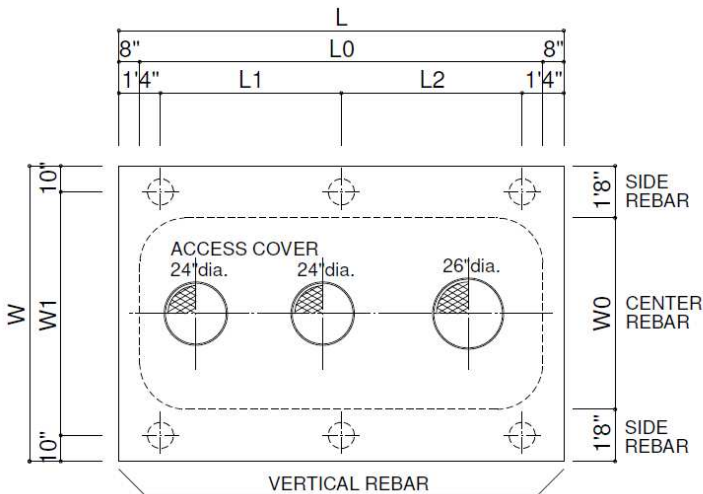

TOP VIEW

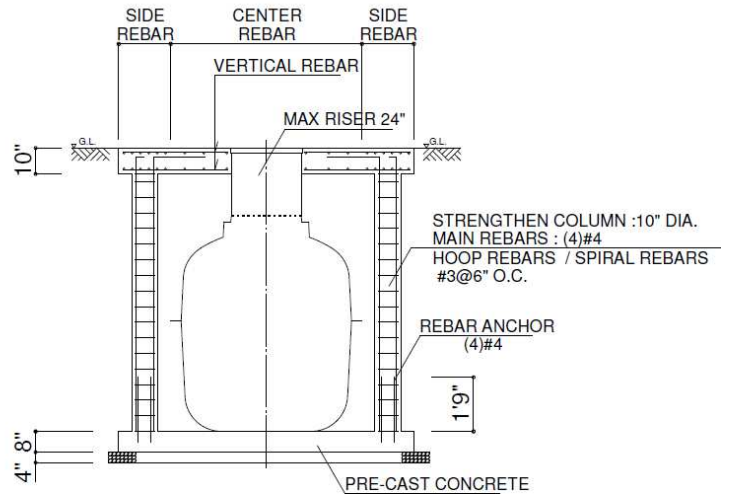

CROSS SECTIONAL VIEW

Rebar Specifications

		CE14	CE21,CEN14	CE30,CEN21
Slab t: 10"	Side Rebar	(5)#5 E.F.	(6)#5 E.F.	
	Vertical Rebar	#5@4" O.C. E.F.		
	Center Rebar	#5@8" O.C. E.F.		
Pillar	Strengthen Column	10" DIA		
	Main Rebar	(4)#4		
	Hoop Rebar / Spiral rebar	#3@6" O.C		
Base	Pre-cast concrete	Thickness: 8"		

□ Step 14 continued: Rebar arrangement details

**SPECIFICATIONS**  
 CONCRETE STRENGTH:  $F'_c = 3100\text{PSI, MIN.}$   
 STEEL WIRE : GRADE 60.  
 CONCRETE COVER : 2-1/2", MIN.  
 ANCHORAGE LENGTH : 40d, MIN.  
 FOUNDATION: 4", MIN. #57 STONE.

\*1 G.L. IN THE DRAWING INDICATES TOP (MANHOLE LID) LEVEL.  
 \*2 TOP LOAD IS DESIGNED FOR H20.

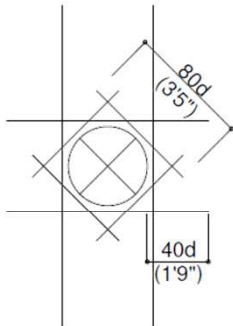

d : DIAMETER OF FERRO REINFORCEMENT MATERIAL

REBAR AROUND ACCESS HOLE

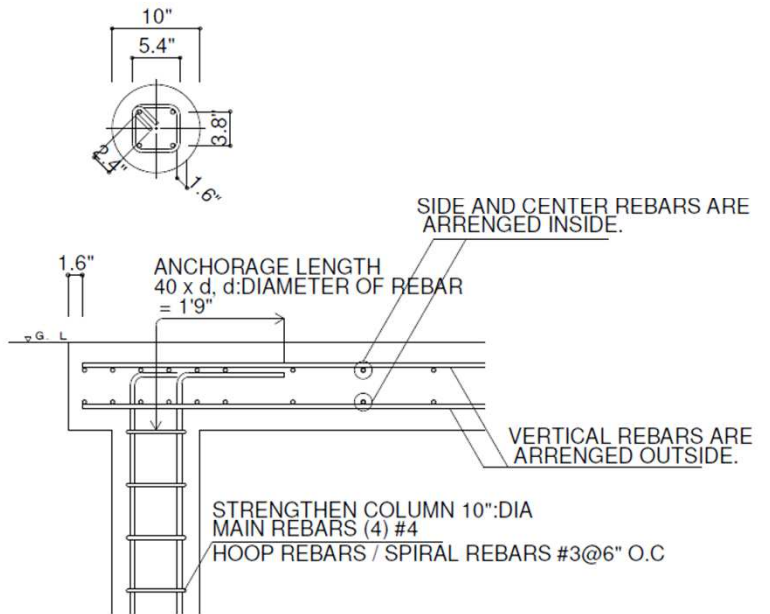

HOOP REBAR / ANCHORAGE LENGTH DETAIL

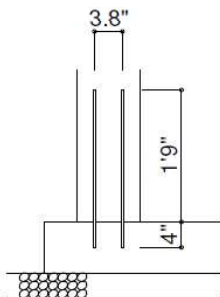

REBAR ANCHOR DETAIL

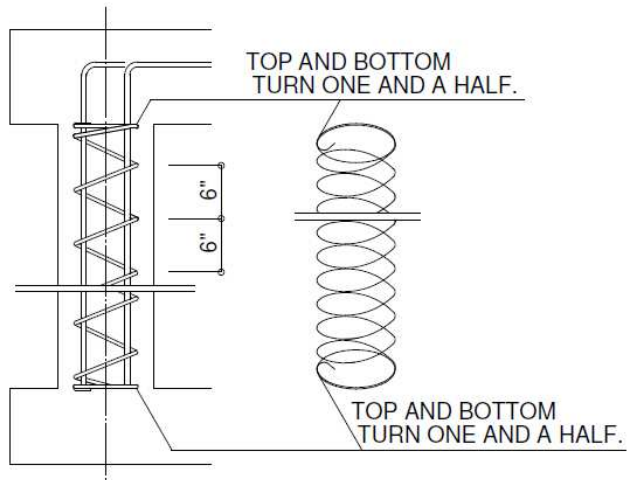
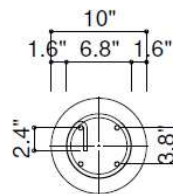

STRENGTHEN COLUMN SPIRAL REBAR

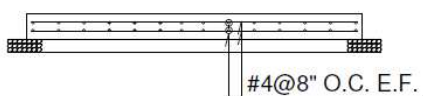

REFERENCE OF REBAR ARRANGEMENT (BASE)



Step 14 continued: Reference information access cover for H-20, HS-20

- Bolt lock type
- Must have holes to move access cover

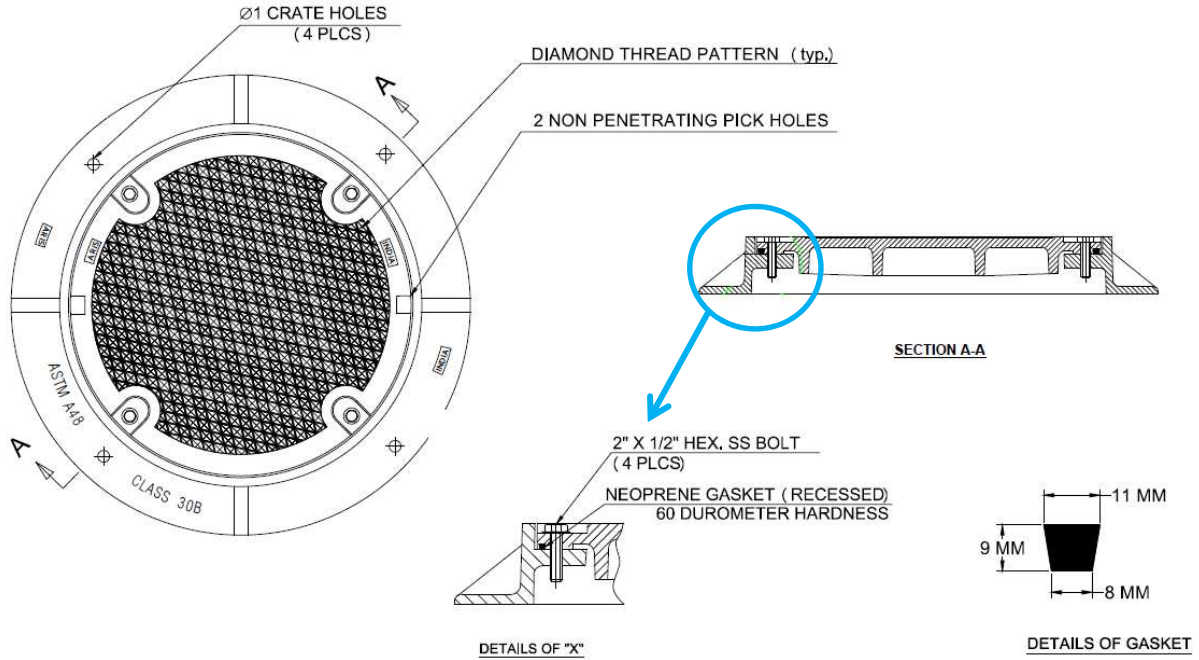

Step 14 continued: Set Rebar arrangement for top slab.

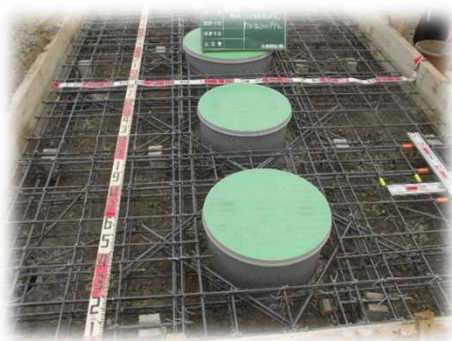

Pour fresh concrete



Cure concrete until hardened.



Step 15: Be sure to pitch final grade away from covers to sweep surface water away from system.

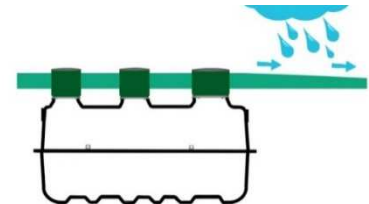

Step 16: Fill out Warranty Activation Card (received with this Installation Manual) and return to FujiClean USA to activate system Warranty. Warranty activation is also available via [www.fujicleanusa.com](http://www.fujicleanusa.com). Please call FujiClean USA for assistance if necessary: 207-406-2927.

**CONTINUATION OF EACH TYPE OF INSTALLATIONS STEPS.**

**Finalize Controller Wiring.** Please have licensed electrician refer to wiring diagram in this Manual and enclosed separately in alarm/control panel. Customized controllers are available with options such as telecommunications or flow monitoring. Contact FujiClean USA for details.



**Control Panel Options**

FujiClean Model	A	A1	C	X	D	RI	RI2	E	M	KG	Suffolk	AR
<b>Features</b>	<b>Basic Alarm Panel.</b> 1. Alarms for high water and blower off. 2. Pressure switch. 3. Ideal if blower is relatively close to panel. 4. Extra breaker to run discharge pump	<b>Basic Alarm Panel w/ Current Sensor</b> 1. Identical to Panel "A" but with a current sensor instead of pressure switch. 2. Ideal if blower is relatively far from panel.	<b>Basic Alarm w/ Comm. Contact &amp; Time Meter</b> 1. Same features as "A" Panel but with relay (for autodialer, remote alarm etc.) 2. Elapsed time meter for discharge pump showing total run time. 3. Typical New Jersey panel	<b>Basic Alarm with 24-Hour Timer (Night Spray)</b> 1. Same features as "A" Panel but with dose timer (example: to be used with discharge pump to dose field at night). 2. Dual alarm beacons. Red for high water. Amber for blower. 3. Typical Texas panel	<b>Duplex Time Dosing</b> 1. Program pump dosing with inexpensive data logging option. Records such items as discharge pump cycles and elapsed run time, alarm frequency etc. 2. Can control up to 2 pumps. 3. Can choose pressure switch or current sensor	<b>Simplex Time Dosing</b> 1. Same features as "Duplex" Panel but can control only 1 discharge pump.	<b>Simple Event Counter</b> 1. Same features as "A1" but with event counter to "count" discharge pump runtime events. 2. Includes HOA switch for discharge pump testing and calibration. 3. Typical Rhode Island panel.	<b>Duplex Dosing Control w/ Data Logging</b> 1. Same features as Panel "D" but with ability to log data and print output reports.	<b>Basic Alarm Panel for Large Systems</b> 1. Same features as "A1" Panel but with capacity for 2 blowers.	<b>Basic Alarm Panel for model CE6KG</b> 1. Same features as "A1" Panel but with capacity for 4 blowers.	<b>Basic Alarm Panel with Current Sensor and Latch</b> 1. Same features as "A1" Panel but with door latch in addition to screws.	<b>Basic Alarm Panel with HOA</b> 1. Same features as "A" Panel but with HOA switch for pump discharge pump testing and calibration. 2. Typical Arkansas panel.
<b>SJE Rhombus Model #</b>	1041972	1064758	1045040	1029522	IFS41W914X6A8 AC10E27D	IFS11W114H6A8 AC15A17G27D w/current sensor	1070525	IFI41W914X6A8 AC10E27D	1059296	BP2833	1069488	1069564
<b>NEMA 4X Weather Proof Enclosure</b>	X	X	X	X	X	X	X	X	X	X	X	X
<b>120 Volt AC Breakers (Pump, Air Pump, Alarm)</b>	3	3	3	3	3	3	3	3	4	3	3	3
<b>Alarm/Test/Normal/Silence Switch</b>	X	X	X	X	X	X	X	X	X	X	X	X
<b>Low Pressure Alarm Switch</b>	X		X	X	X	X*						X
<b>Current Sensor Alarm Switch</b>		X				X*	X	X	X (2)	X(4)	X	
<b>Communication Contacts (Alarm Aux)</b>			X		X	X		X	X			
<b>Elapsed Time Meter</b>			X		X	X		X				
<b>Duplex Pump Demand or Timed Dosing Control</b>					X	X		X				
<b>24-Hour Timer</b>				X	X	X						
<b>Dual Alarm Beacons</b>				X								
<b>Data Logging (Screen Display)</b>					X	X						
<b>Data Logging Panel via USB Port to Flash Drive</b>								X				
<b>UL Listed to Meet and/or Exceed Industry Safety Standards</b>					X	X		X				
<b>Dual Safety Certification for U.S and Canada</b>					X	X		X				

\* Can select either pressure switch or current sensor

☐ For models CE30 and CEN21: CONTROL PANEL “M”

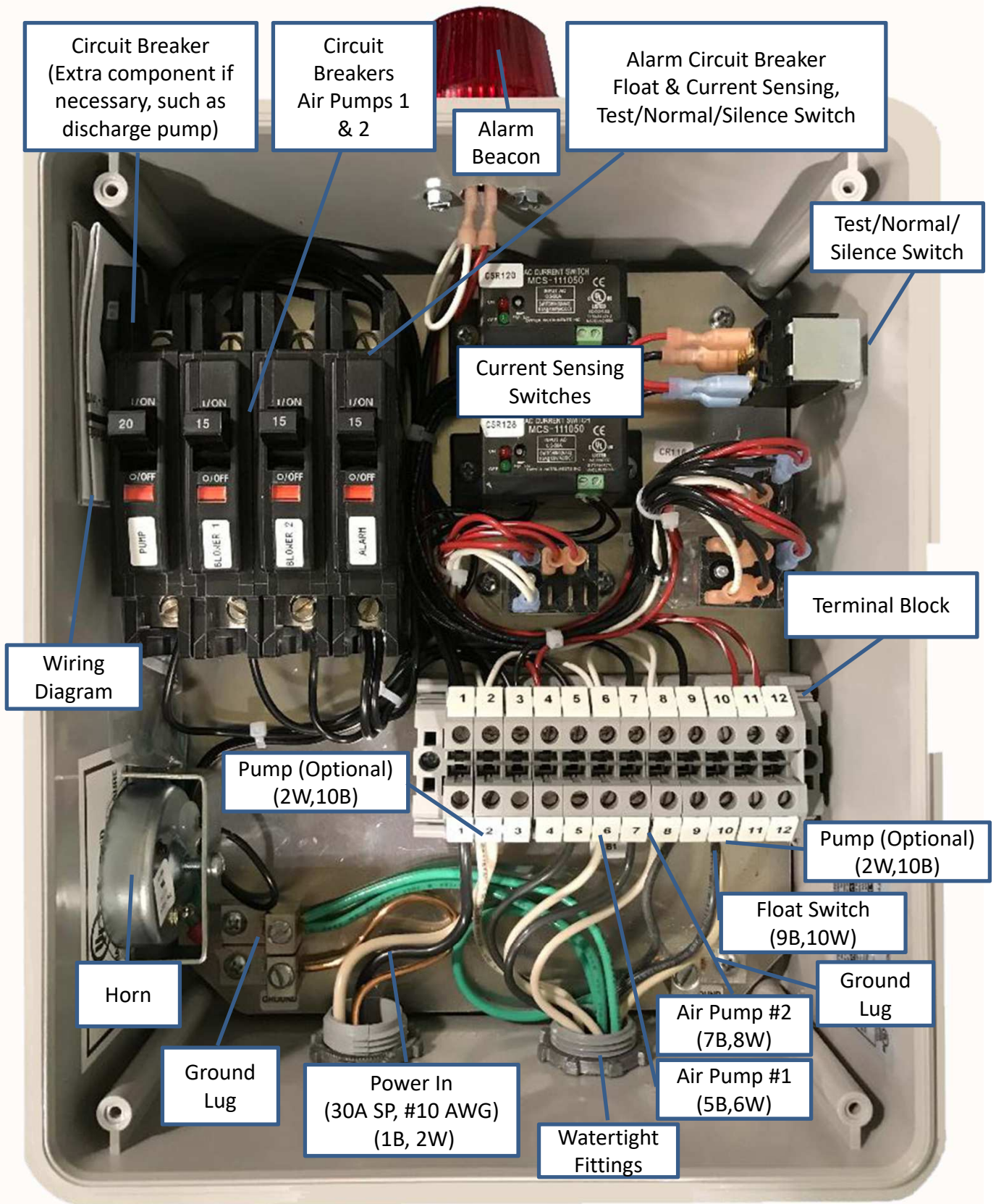

**Important note for all panels with current sensors.** Current sensors have an adjustable range of .5-50 Amps. Sensitivity is controlled with a screw dial. If screwed down to "Low" it would be set to monitor for .5 Amps. If the screw is rotated to "High" it would be set to monitor for 50 Amps.

To set properly, turn the screw dial all the way to "High" then activate the compressor (alarm can be silenced) and slowly rotate the dial towards low until the red LED illuminates on the current sensor. When the red LED is illuminated, the alarm should turn off.

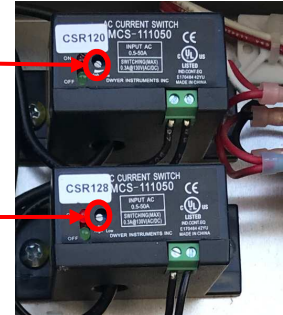

## “M” Control Panel Wiring Diagram p.1

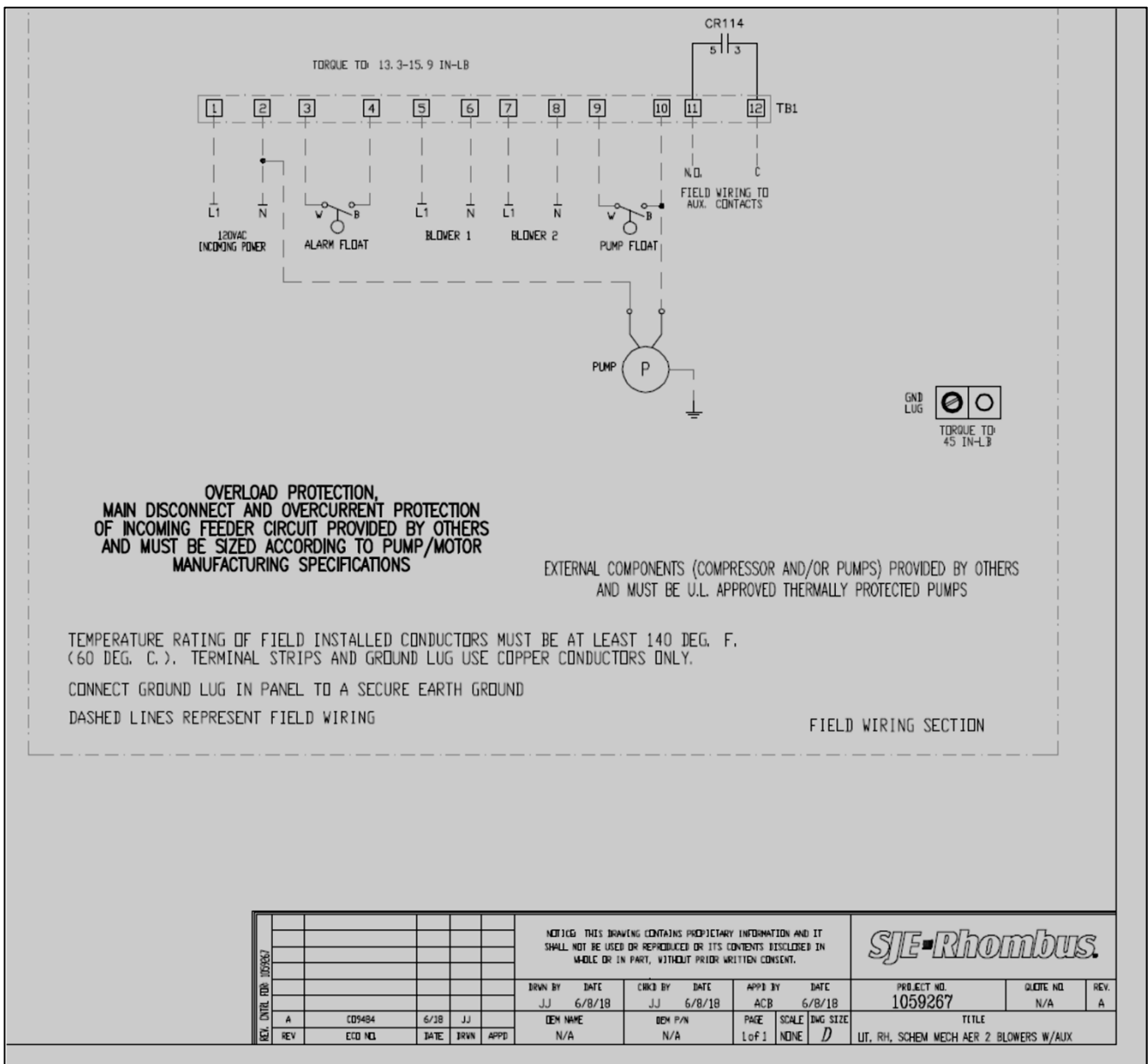



## "M" Control Panel Wiring Diagram p.2

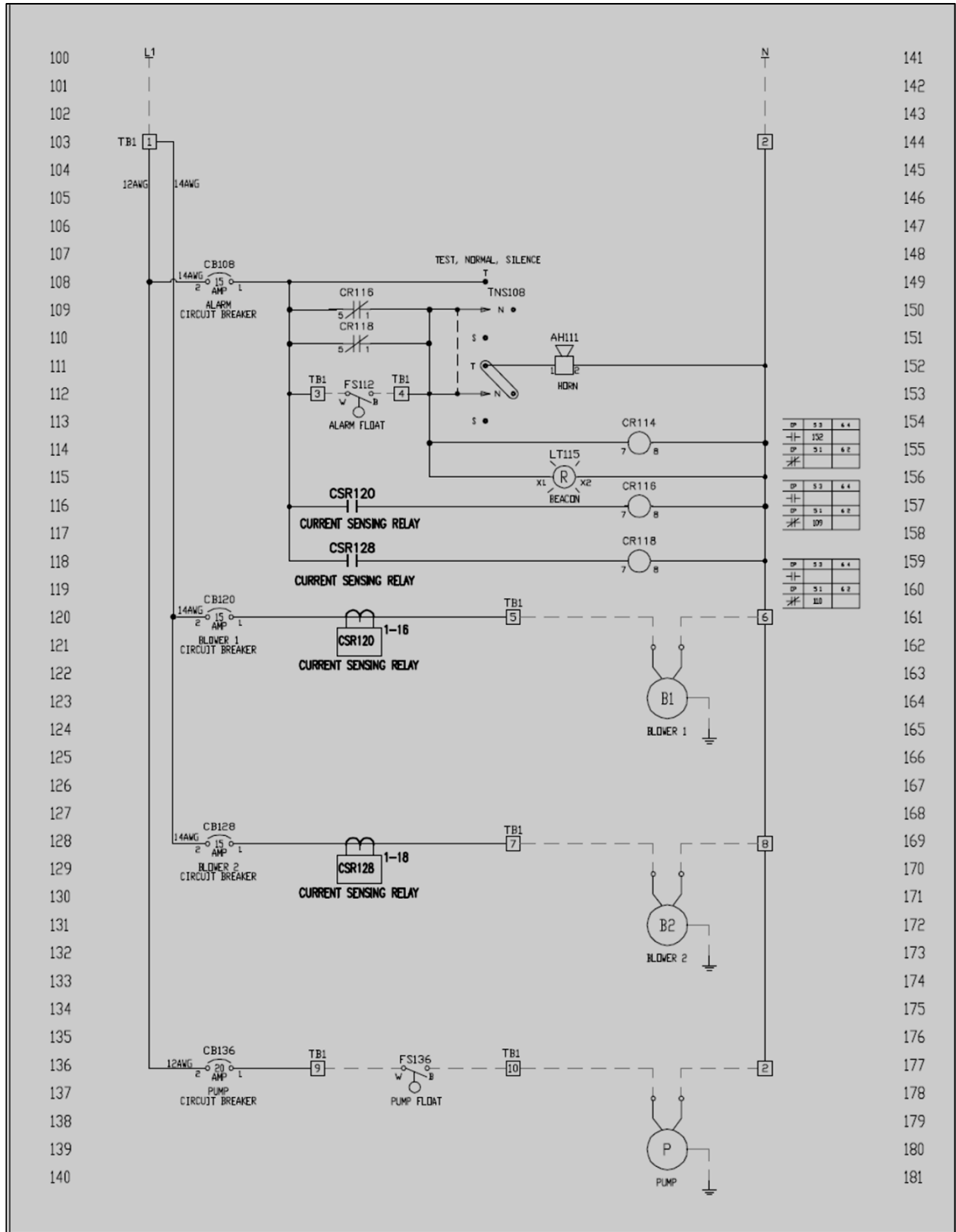

❑ CONTROL PANEL "A"

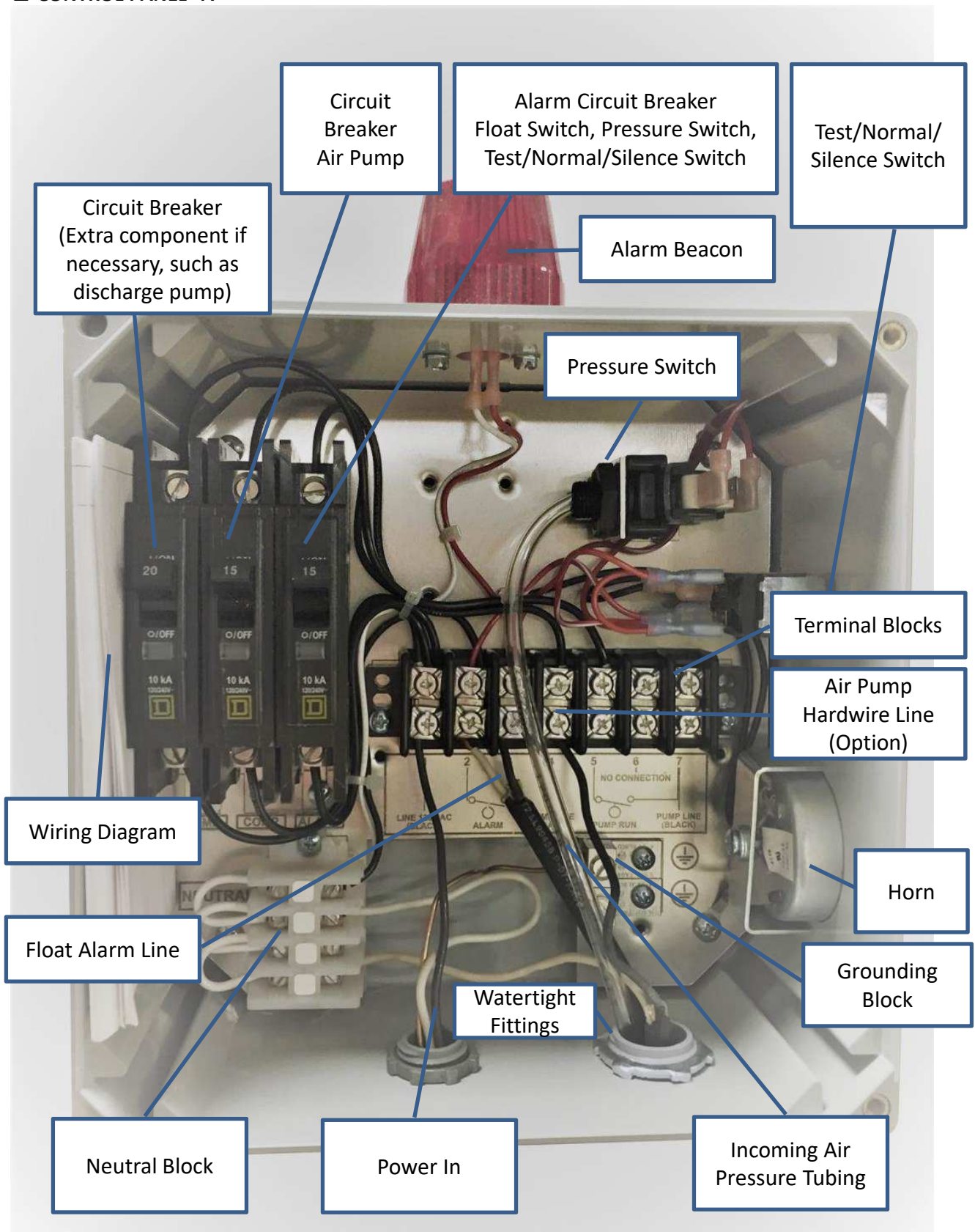

## "A" Control Panel Wiring Diagram p.1

Please provide wiring diagram to licensed electrician for making proper electrical connections. (A copy of this diagram is also provided inside NEMA 4X rated control panel enclosure).

Please Note: The basic FujiClean control panel does not come equipped with a timer or timing device. Please contact your distributor for this and other alarm/controller upgrade options.

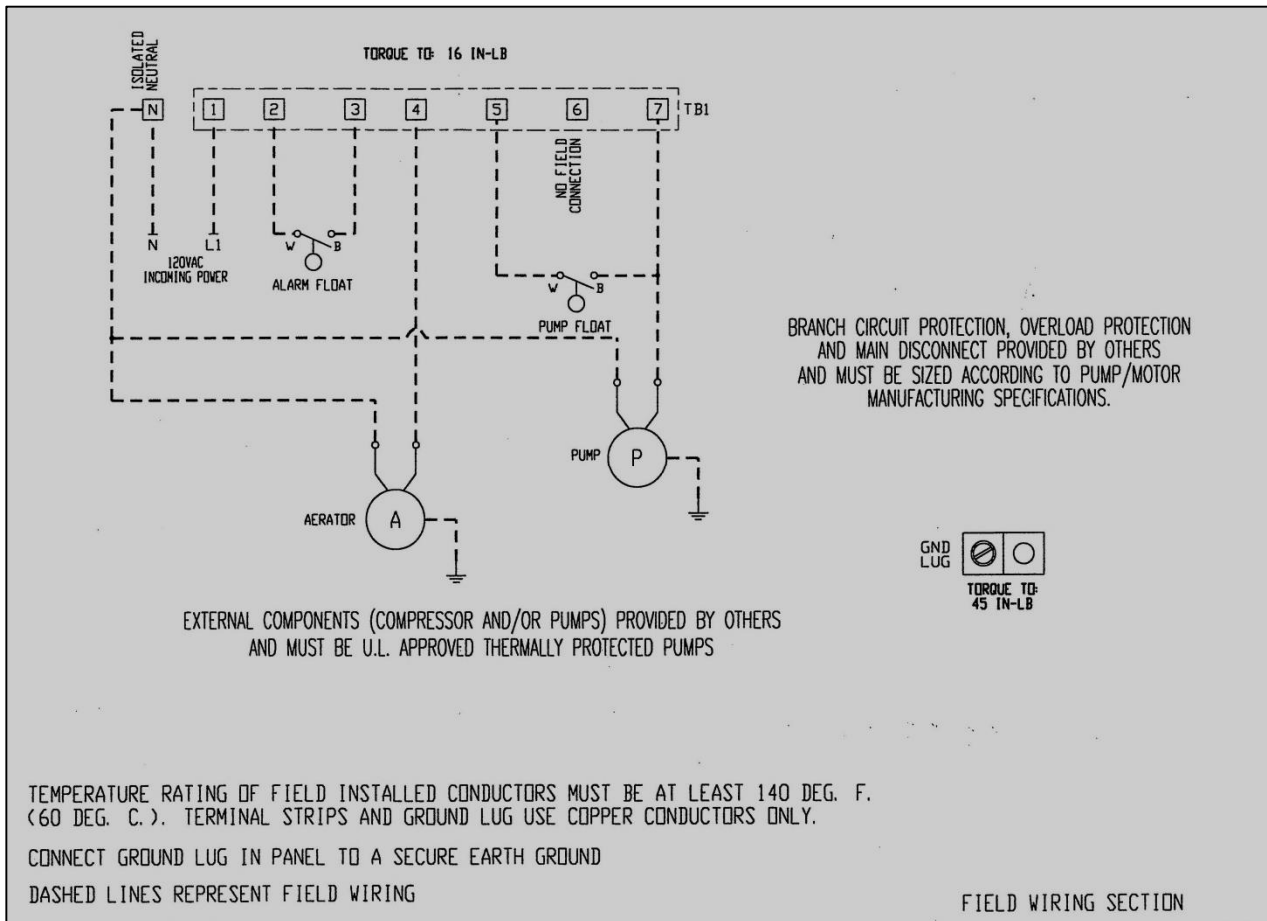

## "A" Control Panel Wiring Diagram p.2

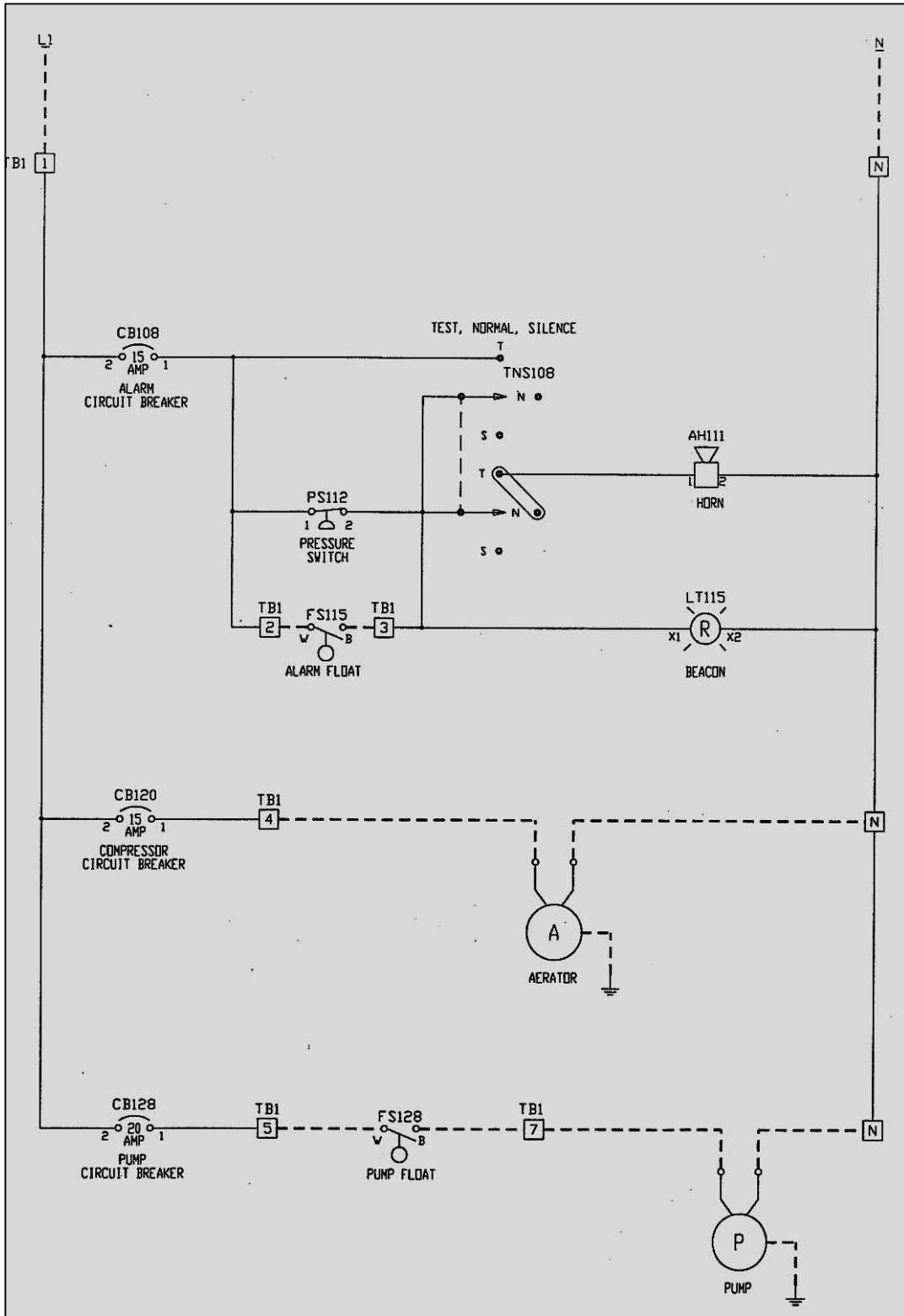



## Float Switch Information

The SJE Rhombus SignalMaster float switch is pre-mounted in FujiClean USA treatment systems. This information from SJE Rhombus is supplied for informed, proper handling during the installation process.

### SJE SIGNALMASTER®



- Mechanically activated.
- Control differential of 1.5 inches above or below horizontal.
- Not sensitive to rotation.
- Mounting options: mounting clamp or cable weight.

**Note:** All hose clamp components are made of 18-8 stainless steel material. See your SJE-Rhombus® supplier for replacements.

**Figure A**

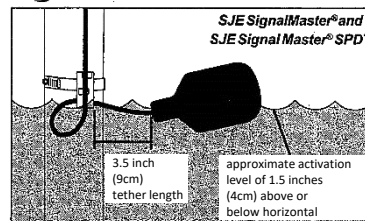

#### ELECTRICAL SHOCK HAZARD

Disconnect power before installing or servicing this product. A qualified service person must install and service this product according to applicable electrical and plumbing codes.



#### EXPLOSION OR FIRE HAZARD

Do not use this product with flammable liquids. Do not install in hazardous locations as defined by National Electric Code, ANSI/NFPA 70.

Failure to follow these precautions could result in serious injury or death. Replace product immediately if switch becomes damaged or severed. Keep these instructions with warranty after installation. This product must be installed in accordance with National Electric Code, ANSI/NFPA 70 so as to prevent moisture from entering or accumulating with in boxes, conduit bodies, fittings, float housing, or cable.

#### PREVENTATIVE MAINTENANCE

- Periodically check the product. Check that the cable has not become worn or that the housing has not been damaged so as to impair the protection of the product. Replace the product immediately if any damage is found or suspected.
- Periodically check to see that the float is free to move and operate the switch.
- Use only SJE Rhombus replacement parts.
- The Sensor Float and Sensor Float Mini control switches contain mercury and **MUST** be recycle or disposed of according to local, state and federal codes.

### SJE-RHOMBUS® THREE-YEAR LIMITED WARRANTY

**SJE-RHOMBUS®** warrants to the original consumer that this product shall be free of manufacturing defects for three years after the date of consumer purchase. During that time period and subject to the conditions set forth below, **SJE-RHOMBUS®** will repair or replace, for the original consumer, any component which proves to be defective due to defective materials or workmanship of **SJE-RHOMBUS®**.

**THIS EXPRESS WARRANTY DOES NOT APPLY TO THE MOTOR START KIT COMPONENT. SJE-RHOMBUS® MAKES NO WARRANTIES OF ANY TYPE WITH RESPECT TO THE MOTOR START KIT.**

**ELECTRICAL WIRING AND SERVICING OF THIS PRODUCT MUST BE PERFORMED BY A LICENSED ELECTRICIAN.**

**THIS WARRANTY DOES NOT APPLY:** (A) to damage due to lightning or conditions beyond the control of **SJE-RHOMBUS®**; (B) to defects or malfunctions resulting from failure to properly install, operate or maintain the unit in accordance with printed instructions provided; (C) to failures resulting from abuse, misuse, accident, or negligence; (D) to units which are not installed in accordance with applicable local codes, ordinances, or accepted trade practices, and (E) to units repaired and/or modified without prior authorization from **SJE-RHOMBUS®**.

*Some states do not allow limitations on how long an implied warranty lasts, so the above limitation may not apply to you. Some states do not allow the exclusion or limitation of incidental or consequential damages, so the above limitation or exclusion may not apply to you. This warranty gives you specific legal rights, and you may also have other rights which vary from state to state.*

**TO OBTAIN WARRANTY SERVICE:** The consumer shall assume all responsibility and expense for removal, reinstallation, and freight. Any item to be repaired or replaced under this warranty must be returned to **SJE-RHOMBUS®**, or such place as designated by **SJE-RHOMBUS®**.

**ANY IMPLIED WARRANTIES OF MERCHANTABILITY OR FITNESS ARE LIMITED TO THE DURATION OF THIS WRITTEN WARRANTY. SJE-RHOMBUS® SHALL NOT, IN ANY MANNER, BE LIABLE FOR ANY INCIDENTAL OR CONSEQUENTIAL DAMAGES AS A RESULT OF A BREACH OF THIS WRITTEN WARRANTY OR ANY IMPLIED WARRANTY.**

# Start-Up Procedures

## □ 1. Outside Environment Check.

FujiClean Treatment System is accessible and nothing inhibits access to maintenance.

- Surface water is draining away from risers and access covers.
- No signs of physical damage to the treatment system, piping, alarms or components.
- No unusual smells around the system.
- No unusually loud air pump noise, such as rattling.

## □ 2. Air Pump Box Check.

- Open the air pump box, make sure that it is operating properly.
- Inspect all fittings and vents to ensure they are clean and dry and that air pump is located so that it is protected from dust and particles, will remain dry and not be submerged.

## □ 3. Air Pump Operation and Air Pump Alarm Check.

- Make sure the air pump operates properly.
- Turn off the air pump (unplug or turn off at alarm/control panel breaker switch) for a few moments to check that the alarm is triggered.

Note: For panels with air pressure switches, it may take a minute or two before air dissipates enough to trigger alarm.

## □ 4. Open all access covers and secure the area around the access openings.

## □ 5. Water Level is at Low Water Level (LWL).

- Check that tank has been filled to LWL mark for all three chambers.

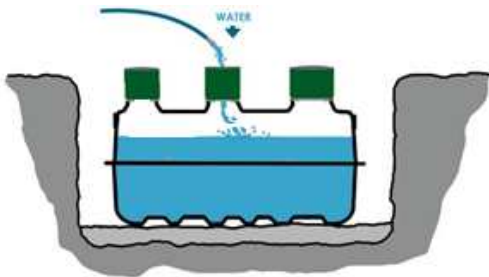

## □ 6. High Water Float Switch Check.

- Check that the high water float switch is operating freely. Lift the high water float switch to check that the alarm is triggered.

(Note: Float should have 3.5" tether. Activation horizon is 1.5" above or below level horizon).

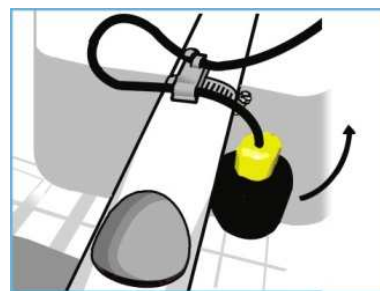
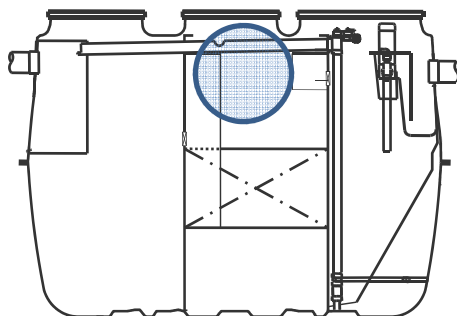

□ **7. Set Recirculation Control Valve (gray), and Recirculation Flow Rate.**

- The recirculation valve should be set according to the table in tank (3<sup>rd</sup> Chamber Label).
- Normal recirculation flow should be level with the top edge of the recirculation pipe line cut-out spilling into Chamber 1.

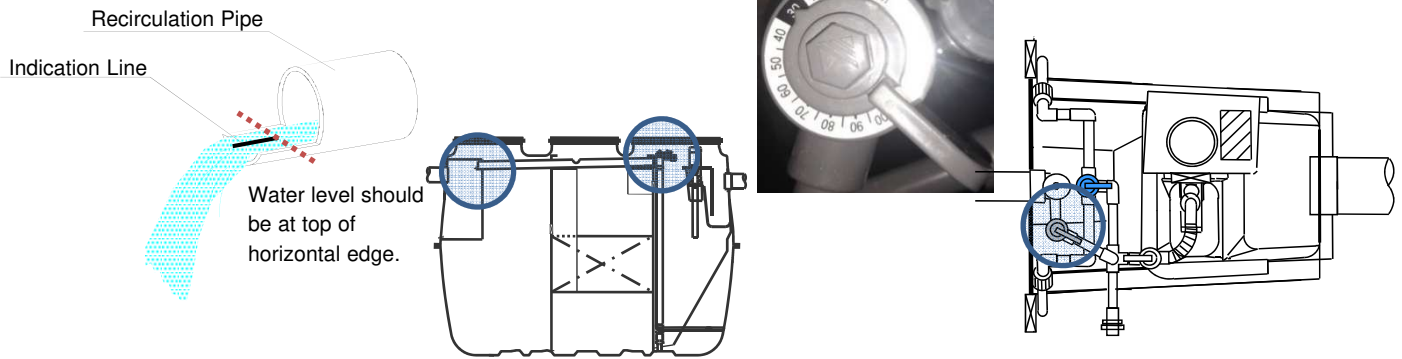

□ **8. Check/Set Aeration Balance Control Valve (blue).**

- The default, normal setting for the Aeration Control Valve is 50%.
- Visually observe the airflow rates on each side of the plant by checking to see if bubbles are evenly distributed on both sides of Chamber 3, the Aeration Chamber. If there is an obvious discrepancy in airflow between the two sides, adjust the Aeration Balance Control Valve so that the airflow is equal. **Important!**

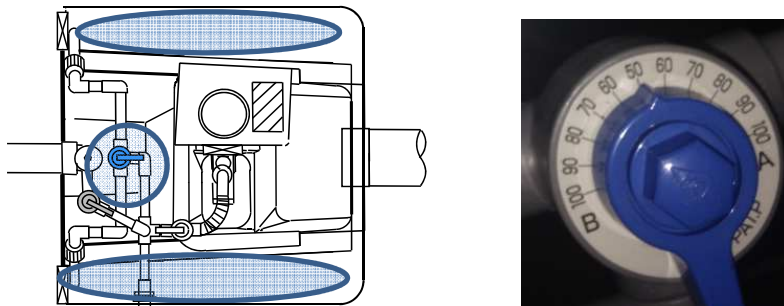

□ **9. Check/Set Effluent Airlift Valve (white).**

- The Effluent Control Valve is initially set to its default setting (as highlighted in black) and there is typically no need for it to be adjusted under standard operating conditions.
- Check the observation port in the airlift line to see if there is smooth water flow from the effluent airlift pump when effluent control valve is turned up.

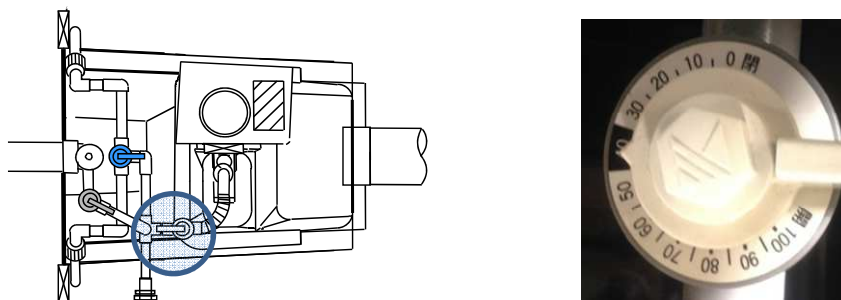

- ❑ **10. Add Disinfectant Tablets to Chlorinator (if applicable).**
  - Open the disinfectant package and place tablets in the cylinder prior to system start-up.
- ❑ **11. Check Alarm/Control Panel and Air Pump.**
  - Check to be sure that Alarm/Control Panel is located in a secure, accessible location.
  - Check fittings and wire connections; they should be tight and secure. This includes connection between air hose and pressure switch.
  - Important: Check to be sure that all panel penetrations are airtight and watertight. Be sure no gas from treatment system can leak into Alarm/Controller.
  - Be sure electrical cord between air pump and outlet is free and clear, and no object is on cord. (Not applicable to hardwired panels).
  - Check to be sure that panel is closed, secure and toggle switch is set to “Normal” setting.
  - If the air pump does not operate, check the air pump auto-stop switch, power cable connection and air pump diaphragm.

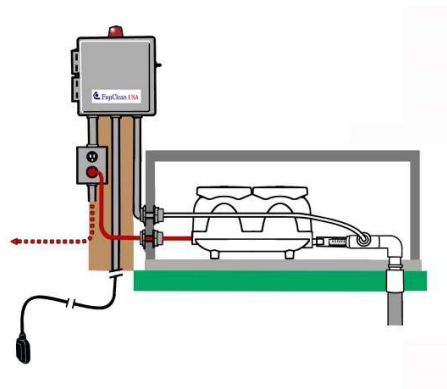

- ❑ **12. Final Site Preparation.**
  - Close and secure all tank access covers.
  - Close and secure air pump protection.

- ❑ **13. Owner Communication**
  - Be sure that business owner has a copy of the FujiClean USA Warranty information.

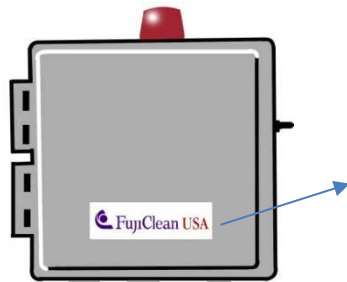



Toward Clean Water...

[www.fujicleanusa.com](http://www.fujicleanusa.com)

SERVICE PROVIDER: \_\_\_\_\_

PHONE: \_\_\_\_\_

- Be sure that service provider contact information is affixed to Alarm/Control Panel.

**Warranty Activation.** Fill out Warranty Activation Card (received with this Installation Manual) and return to FujiClean USA to activate system Warranty. Warranty activation is also available via [www.fujicleanusa.com](http://www.fujicleanusa.com). Please call FujiClean USA for assistance if necessary: 207-406-2927.







### No-Traffic Area Installation Procedure Checklist

**Note:** Please consult Installation Manual for detailed instructions.

#### Unloading Instructions:

- Upon delivery, inspect FujiClean tank, both outside and inside for possible damage incurred during transport. If you find damage, or have a question, please contact your distributor immediately.
- Step 1: Prepare excavation to be at least 1 to 2 feet larger than the FujiClean tank dimensions. Note: Riser height should not exceed 24".**
- Step 2: Prepare 4"- 6" bed of stone (1/8") sand, or poured concrete level to within 1/8".**
- Step 3: Use 4-point lifting lugs. Carefully lower and set tank. Level to within 1/8-inch per 2-ft.**
- Step 4: If any part of the tank is below the estimated seasonal high water table, adequate tank uplift restraint measures should be taken. Please refer to Installation Manual for recommended options.**
- Step 5: Fill tank with fresh water to the low water line in ALL 3 chambers. Re-check that tank is level to 1/8-inch per 2-ft., (fore and aft as well as side to side) and then fill tank with fresh water to the low water line (marked inside tank). Start 24-hour water tightness test. (Please contact your distributor or FujiClean USA if water level has dropped after 24 hours).**
- Step 6: Backfill about ¾ way up tank in layered, compacted 6" lifts using peastone or equivalent material that form-fits into tank corrugations. Install inlet/outlet lines using 5x4 reducing bushing if necessary.**
- Step 7: 3/4" PVC air line pipe can insert to the tank directly. Connect 3/4" or 1" conduit that is chosen by distance in prepared trench (min. 6" deep) to location of air pump. For CE5-10 and CEN5-10, CE14, 21, CEN10 and 14 locate air pump within 33' for ¾" or 1" air line or 100' for 1" air line. For CE30 and CEN21 use 1" air line. Connect with no more than 5 elbows on each models. If site conditions prevent this configuration, contact your distributor or FujiClean USA for technical assistance.**
- Step 8: Locating and Installing Air Pump/ Control Panel.**
  - Air Pump shall be:**
    - ✓ in as close proximity to control panel as possible
    - ✓ on a solid (e.g. concrete) pad to minimize vibrations
    - ✓ in a location above water level
    - ✓ away from grease exhaust fans.
    - ✓ away from bedroom windows and other locations where operational sounds (although minimal) may be a nuisance
    - ✓ In a location that allows unencumbered access for inspection and maintenance activity
    - ✓ with proper electrical grounding
    - ✓ with wiring and electrical connections made by a licensed electrician.
    - ✓ with no objects on top of electrical cord.
    - ✓ in a well-ventilated space out of direct sunlight and protected from elements such as direct rain or snowfall.

## **No-traffic Area Installation Procedure Checklist continued:**

- Step 8 continued:**
  - Alarm Panel shall be:**
    - ✓ in a well-ventilated area as dry and protected from elements as possible
    - ✓ in as close of proximity to FujiMAC air pump as possible
    - ✓ wired by licensed electrician
    - ✓ in a location that allows unencumbered access for inspection and maintenance activity
- Step 9:** For cold climate installations, please install insulated risers and covers. Cover upper half of treatment unit with min. R-8 value insulating material (i.e. foam board)
- Step 10:** Float switch electrical cord should exit riser wall through a male adaptor (caulked watertight to prevent septic gas leakage) or watertight fitting. An interior connection to direct burial cable is also an acceptable option.
- Step 11:** The system must be vented. In nearly all cases, the FujiClean system will vent properly through the building's septic influent line. In cases where there is an influent pump, or in severe downdraft locations, a separate vent should be considered. If you do choose to install a vent, be sure that the vent slopes toward the tank so that any moisture accumulation drips back down toward the tank.
- Step 12:** During final landscaping, seeding etc., be sure to pitch final grade away from covers to sweep surface water away from treatment tank.
- Step 13:** Complete Warranty Activation Card.
- Step 14:** Finalize Controller Wiring. Please have licensed electrician refer to wiring diagram (in Installer Manual and enclosed separately in alarm/control panel). Upgraded FujiClean USA controllers are available if telecommunications, elapsed time meter, data logging or other functions are required. Please contact FujiClean USA for details.
- Step 15:** Follow start-up procedure detailed in Installation Manual:
  - 1. Outside Environment Check
  - 2. Air Pump Box Check
  - 3. Air Pump Operation and Air Pump Alarm Check
  - 4. Open all access covers
  - 5. Water Level is at Low Water Level
  - 6. High Water Float Switch Check
  - 7-1. Set Recirculation Control Valve. (gray)
  - 7-2. Check Recirculation Flow Rate
  - 8. Check/Set Aeration Balance Control Valve (blue)
  - 9-1. Check/Set Effluent Airlift Valve (white)
  - 9-2. Check Effluent Airlift Pipe
  - 10. Add Disinfectant Tablets to Chlorinator (if appropriate)
  - 11. Check Alarm/Control Panel and Air Pump
  - 12. Final Site Preparation
  - 13. Owner Communication - Service Provider and Warranty Delivery



### Installation Procedure Checklist for H-20, HS-20, Traffic-Rated Tank and No Support Columns

**Note:** Please consult Installation Manual for detailed instructions.

#### **Unloading Instructions:**

- Upon delivery, inspect FujiClean tank, both outside and inside for possible damage incurred during transport. If you find damage, or have a question, please contact your distributor immediately.
- Step 1: Prepare excavation following this instruction and drawing plan. Importance: Distance between ground level and adapter ring is 24 inches.**
- Step 2: Prepare 4"- 6" bed of stone (1/8").**
- Step 3: Set pre-cast concrete or pour concrete base. In case of Traffic-Rated Tank, install the concrete box accurately.**
- Step 4: Use 4-point lifting lugs. Carefully lower and set tank. Level to within 1/8-inch per 2-ft..**
- Step 5: Fill tank with fresh water to the low water line in ALL 3 chambers. Re-check that tank is level to 1/8-inch per 2-ft., (fore and aft as well as side to side) and then fill tank with fresh water to the low water line (marked inside tank). Start 24-hour water tightness test. (Please contact your distributor or FujiClean USA if water level has dropped after 24 hours).**
- Step 6: Backfill about ¾ way up tank in layered, compacted 6" lifts using peastone or equivalent material that form-fits into tank corrugations. Install inlet/outlet lines using 5x4 reducing bushing if necessary.**
- Step 7: 3/4" air line pipe can connect to the tank directly. Connect 3/4" or 1" conduit that is chosen by distance in prepared trench (min. 6" deep) to location of air pump. For CE14, CE21, CEN14, locate air pump within 33' for ¾" or 1" air line or 100' for 1" air line. For CE30 and CEN21 use 1" air line. Connect with no more than 5 elbows on each models.**
- Step 8: Locating and Installing Air Pump/ Control Panel.**
  - Air Pump shall be:**
    - ✓ in as close proximity to control panel as possible
    - ✓ on a solid (e.g. concrete) pad to minimize vibrations
    - ✓ in a location above water level
    - ✓ away from grease exhaust fans.
    - ✓ away from bedroom windows and other locations where operational sounds (although minimal) may be a nuisance
    - ✓ In a location that allows unencumbered access for inspection and maintenance activity
    - ✓ with proper electrical grounding
    - ✓ with wiring and electrical connections made by a licensed electrician.
    - ✓ with no objects on top of electrical cord.
    - ✓ in a well-ventilated space out of direct sunlight and protected from elements such as direct rain or snowfall.

## Installation Procedure for H-20, HS-20 Checklist continued:

- Step 8 continued :
  - Alarm Panel shall be:
    - ✓ in a well ventilated area as dry and protected from elements as possible
    - ✓ in as close of proximity to FujiMAC air pump as possible
    - ✓ wired by licensed electrician
    - ✓ in a location that allows unencumbered access for inspection and maintenance activity
  
- Step 9: Float switch electrical cord connect through a male adaptor (caulked watertight to prevent septic gas leakage) or watertight fitting. An interior connection to direct burial cable is also an acceptable option.
  
- Step 10: The system must be vented. In nearly all cases, the FujiClean system will vent properly through the building's septic influent line. In cases where there is an influent pump, or in severe downdraft locations, a separate vent should be considered. If you do choose to install a vent, be sure that the vent slopes toward the tank so that any moisture accumulation drips back down toward the tank.
  
- Step 11: Backfill up to under slab level. Make sure to compact tightly.
  
- Step 12: Set access covers and rebar arrangement for top slab. Perform concrete work and cure concrete until hardened. Be sure water drains from slab.
  
- Step 13: During final landscaping, seeding etc., be sure to pitch final grade away from covers to sweep surface water away from treatment tank.
  
- Step 14: Complete Warranty Activation Card.
  
- Step 15: Finalize Controller Wiring. Please have licensed electrician refer to wiring diagram (in Installer Manual and enclosed separately in alarm/control panel). Upgraded FujiClean USA controllers are available if telecommunications, elapsed time meter, data logging or other functions are required. Please contact FujiClean USA for details.
  
- Step 16: Follow start-up procedure detailed in Installation Manual:
  - 1. Outside Environment Check
  - 2. Air Pump Box Check
  - 3. Air Pump Operation and Air Pump Alarm Check
  - 4. Open all access covers
  - 5. Water Level is at Low Water Level
  - 6. High Water Float Switch Check
  - 7-1. Set Recirculation Control Valve. (gray)
  - 7-2. Check Recirculation Flow Rate
  - 8. Check/Set Aeration Balance Control Valve (blue)
  - 9-1. Check/Set Effluent Airlift Valve (white)
  - 9-2. Check Effluent Airlift Pipe
  - 10. Add Disinfectant Tablets to Chlorinator (if appropriate)
  - 11. Check Alarm/Control Panel and Air Pump
  - 12. Final Site Preparation
  - 13. Owner Communication - Service Provider and Warranty Delivery





## Installation Procedure Checklist for H-20, HS-20 with Support Columns

**Note:** Please consult Installation Manual for detailed instructions.

### **Unloading Instructions:**

- Upon delivery, inspect FujiClean tank, both outside and inside for possible damage incurred during transport. If you find damage, or have a question, please contact your distributor immediately.
- Step 1: Prepare excavation following this instruction and drawing plan. Note: Riser height should not exceed 24".**
- Step 2: Prepare 4"- 6" bed of stone (1/8").**
- Step 3: Set pre-cast concrete or pour concrete base.**
- Step 4: Set Adhesive anchor for binding foundation and column (4)#4 and set rebar and PVC tube or Concrete form tube for pillar. Pour concrete to tubes.**
- Step 5: Use 4-point lifting lugs. Carefully lower and set tank. Level to within 1/8-inch per 2-ft.**
- Step 6: Fill tank with fresh water to Low Water Level (LWL) mark in all 3 chambers. Re-check that tank is level to 1/8-inch per 2-ft., (fore and aft as well as side to side) and then fill tank with fresh water to the low water line (marked inside tank). Start 24-hour water tightness test. (Please contact your distributor or FujiClean USA if water level has dropped after 24 hours).**
- Step 7: After concrete is hardened on support columns, backfill about ¾ way up tank in layered, compacted 6" lifts using peastone or equivalent material that form-fits into tank corrugations. Install inlet/outlet lines using 5x4 reducing bushing if necessary.**
- Step 8: 3/4" air line pipe can connect to the tank directly. Connect 3/4" or 1" conduit that is chosen by distance in prepared trench (min. 6" deep) to location of air pump. For CE14, CE21 and 14, locate air pump within 33' for ¾" or 1" air line or 100' for 1" air line. For CE30 and CEN21 use 1" air line. Connect with no more than 5 elbows on each models.**
- Step 9: Locating and Installing Air Pump/ Control Panel.**

#### Air Pump shall be:

- ✓ in as close proximity to control panel as possible
- ✓ on a solid (e.g. concrete) pad to minimize vibrations
- ✓ in a location above water level
- ✓ away from grease exhaust fans.
- ✓ away from bedroom windows and other locations where operational sounds (although minimal) may be a nuisance
- ✓ In a location that allows unencumbered access for inspection and maintenance activity
- ✓ with proper electrical grounding
- ✓ with wiring and electrical connections made by a licensed electrician.
- ✓ with no objects on top of electrical cord.
- ✓ in a well-ventilated space out of direct sunlight and protected from elements such as direct rain or snowfall.

**Installation Procedure for H-20, HS-20**  
**with Support Columns Checklist continued:**

- Step 9 continued:
  - Alarm Panel** shall be:
    - ✓ in a well ventilated area as dry and protected from elements as possible
    - ✓ in as close of proximity to FujiMAC air pump as possible
    - ✓ wired by licensed electrician
    - ✓ in a location that allows unencumbered access for inspection and maintenance activity
  
- Step 10: Float switch electrical cord connect through a male adaptor (caulked watertight to prevent septic gas leakage) or watertight fitting. An interior connection to direct burial cable is also an acceptable option.
  
- Step 11: For cold climate installations, please install insulated risers and covers and cover upper half of treatment unit with min. R-8 value insulating material (i.e. foam board)
  
- Step 12: The system must be vented. It will vent through the building's septic influent line and building plumbing or a separate vent. If you do choose to install a vent, be sure that the vent slopes toward the tank.
  
- Step 13: Backfill up to under slab level. Make sure to compact tightly.
  
- Step 14: Set access covers and rebar arrangement for top slab. Perform concrete work and cure concrete until hardened. Be sure water drains from slab.
  
- Step 15: During final landscaping, seeding etc., be sure to pitch final grade away from covers to sweep surface water away from treatment tank.
  
- Step 16: Complete Warranty Activation Card.
  
- Step 17: Finalize Controller Wiring. Please have licensed electrician refer to wiring diagram (in Installer Manual and enclosed separately in alarm/control panel). Upgraded FujiClean USA controllers are available if telecommunications, elapsed time meter, data logging or other functions are required. Please contact FujiClean USA for details.
  
- Step 18: Follow start-up procedure detailed in Installation Manual:
  - 1. Outside Environment Check
  - 2. Air Pump Box Check
  - 3. Air Pump Operation and Air Pump Alarm Check
  - 4. Open all access covers
  - 5. Water Level is at Low Water Level
  - 6. High Water Float Switch Check
  - 7-1. Set Recirculation Control Valve. (gray)
  - 7-2. Check Recirculation Flow Rate
  - 8. Check/Set Aeration Balance Control Valve (blue)
  - 9-1. Check/Set Effluent Airlift Valve (white)
  - 9-2. Check Effluent Airlift Pipe
  - 10. Add Disinfectant Tablets to Chlorinator (if appropriate)
  - 11. Check Alarm/Control Panel and Air Pump
  - 12. Final Site Preparation
  - 13. Owner Communication - Service Provider and Warranty Delivery