

PROGRAMMING INSTRUCTIONS / ALARM CONDITIONS

TURN DIAL TO DESIRED PARAMETER, PRESS IN DIAL, TURN DIAL TO MAKE CHANGES, PRESS IN DIAL TO SET

PARAMETERS / ALARMS	OPERATION
CLOCK	SET TO CURRENT TIME (PRESS IN DIAL ON HOME SCREEN TO CHOOSE 12HR OR 24HR CLOCK)
TIMER 1,2,3,4	TIME OF DAY TO RUN PUMP WHEN PUMP FLOAT IS UP
AERO SET	IF AERATOR AMP VALUE DROPS BELOW "AERO SET", THE ALARM ACTIVATES, SET 0 FOR NO ALARM
AERATOR ALARM	**ALARM BEACON FLASHING** = AERATOR FAIL
FLOAT ALARM	**ALARM BEACON ON (STEADY)** = HIGH WATER ALARM (FLOAT)

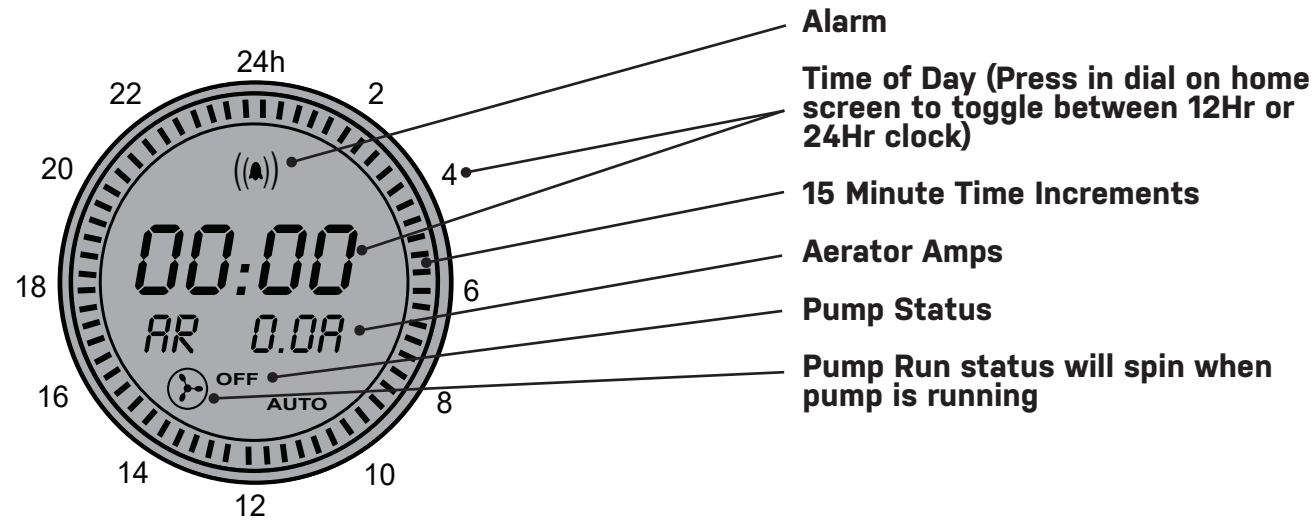

Elapsed time meter and cycle counter for pump and aerator included. To toggle between ETM and CC, press in the dial when on pump or aerator counter screens.

QUICK START PROGRAMMING

After panel and float installation, the Digital Display will need to be programmed with the following:

- Clock - Current Time of Day - 12hr or 24hr
- Timer 1 - The time of day your pump is allowed to run when float is up.
- Timer 2 - Optional - The time of day your pump is allowed to run when float is up.
- Timer 3 - Optional - The time of day your pump is allowed to run when float is up.
- Timer 4 - Optional - The time of day your pump is allowed to run when float is up.
- Aero Set - Set the Aerator Amp detection value. Should the Aerator fail (open circuit), the alarm will become active. Set to 0.0A to disable this alarm.

To set Clock, turn dial until clock is displayed, press in for enter, turn dial until the current time of day is displayed and press in dial again. (Press in dial on home screen to toggle between 12hr or 24hr clock.)

To set Timer, turn dial until Timer 1 is displayed, press in for enter, turn dial to the correct start time, press in dial, turn dial to the correct stop time, press dial.

To set Aerator Amps, turn dial until Aero Set is displayed, press in for enter, turn dial to the desired low amp alarm value of the Aerator, and press dial. If no alarm is wanted, set amps to 0.0.

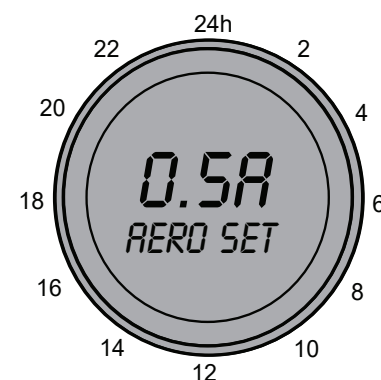
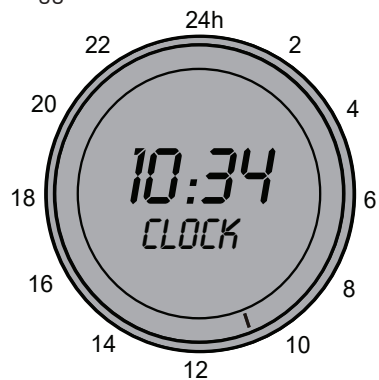

DIGITAL AEROBIC
Single Phase Simplex

Installation and Operation Manual

U.S. Patent 10,251,284



Specifications

- Input Voltage:** 120 VAC
- Pump Ratings:** 15 Amps at 120 VAC
- Aerator/Alarm Ratings:** 10 Amps at 120 VAC
- Enclosure:** 8 x 6 x 4 inch NEMA 4X thermoplastic
- Operating Temperature:** 14°F to 122°F

WARNING!
ELECTRICAL SHOCK HAZARD
 Disconnect all power sources before servicing. Failure to do so could result in serious injury or death.

This control panel must be installed and serviced by a licensed electrician in accordance with the National Electric Code NFPA-70, state and local electrical codes. UL Type 4X enclosures are for indoor or outdoor use.

Warranty void if panel is modified.

For information regarding operation, available options, or servicing questions, please call an SJE Rhombus customer service technician:

1-800-Rhombus (1-800-746-6287)
 Monday-Friday, 7:00 AM to 6:00 PM Central Time

SJE Rhombus offers a five-year limited warranty. For complete terms and conditions, please visit www.sjehombus.com.

Products returned must be cleaned, sanitized, or decontaminated as necessary prior to shipment to ensure that employees will not be exposed to health hazards in handling said material. All applicable laws and regulations shall apply.

Manufactured by: SJE Rhombus

Technical Support: +1-800-746-6287

techsupport@sjehombus.com

www.sjehombus.com

Technical Support Hours: Monday-Friday, 7 A.M. to 6 P.M. Central Time

Installing the Float Switches

The Digital Aerobic Single Phase Simplex control panel operates with three float switches (sold separately). They activate PUMP, TIMER OVERRIDE, and high-level ALARM functions.

1 ⚠️ WARNING!

Ensure all power is turned OFF before installing floats in tank. Failure to do so could result in serious or fatal shock.

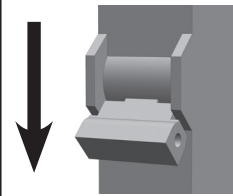

2 ⚠️ CAUTION!

If the floats are not properly mounted and connected in the correct order, the pump will not function properly.

Floats require free range of motion. They must not touch each other or any equipment in the pump chamber.

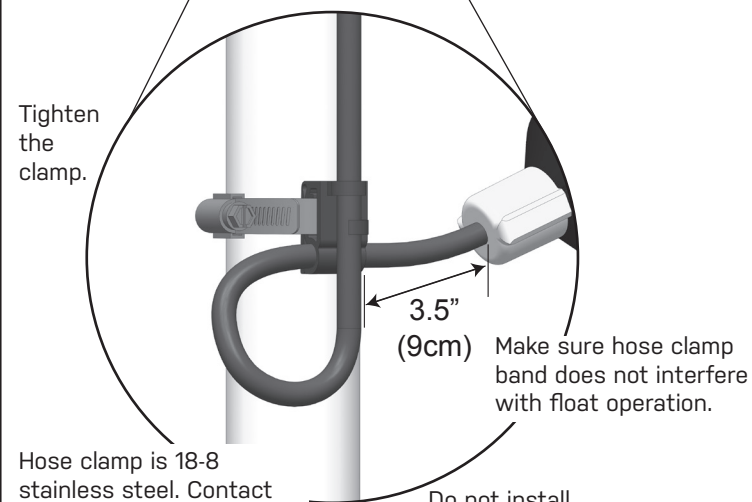
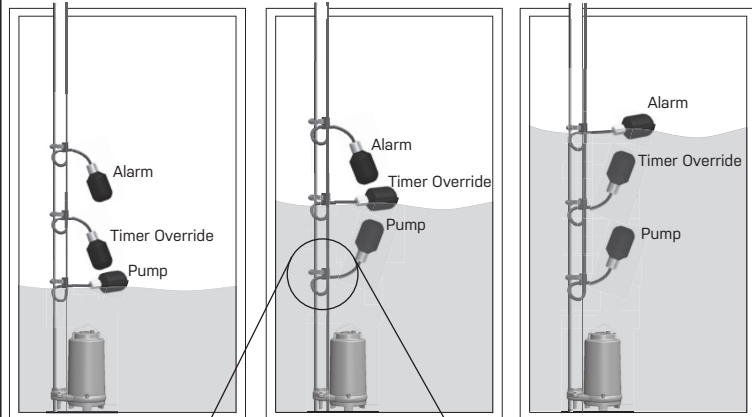

Tighten the clamp.

Hose clamp is 18-8 stainless steel. Contact your SJE Rhombus supplier for replacements.

Make sure hose clamp band does not interfere with float operation.

Do not install cord under hose clamp.

Mounting the Control Panel

NOTE

If the distance to the control panel exceeds the length of the float switch cords or the pump power cord, splicing in a liquid-tight junction box will be required. For outdoor or wet installation, we recommend an SJE Rhombus, UL Type 4X junction box.

- 1 Drill and install top fastener using appropriate anchor if necessary.



- 2 Drill and install a bottom fastener using appropriate anchor if necessary.

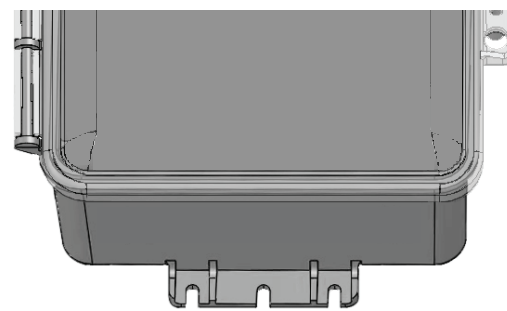

Wiring the Control Panel

- 1 Determine conduit entrance locations on control panel as shown. Check local codes and schematic on the inside cover of the panel for the number of power circuits required.

⚠️ CAUTION!

Be sure the pump power voltage and phase are the same as the pump motor being installed. Use of separate pump and control/alarm power sources is recommended.

- 2 Connect the following wires to the proper terminal positions:
 - incoming power for pump circuit
 - incoming power for aerator/alarm circuit
 - pump
 - float switches
 - aerator
- 3 Verify correct operation of control panel after installation is complete.

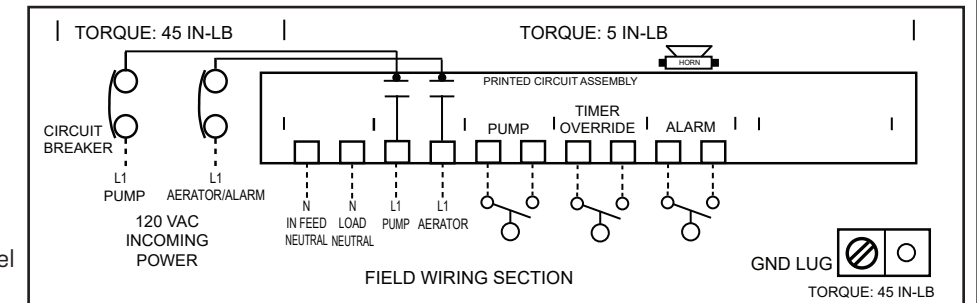

Operations

SJE Rhombus Digital Aerobic simplex control panel controls and monitors an aerator, pump, and high water level in aerobic wastewater treatment applications. The pump will run if the pump float is up (closed) and one of the 4 timers are set to allow the pump to run at that time. The aerator will run at all times and the display will show the amps in real time. If the amps fall below the AERO SET point, the alarm will be activated. If aerator is not used, AERO SET can be set at 0.0 amps to disable the alarm. Beacon indicates two different alarm conditions, solid alarm for high water and flashing alarm for aerator fail.

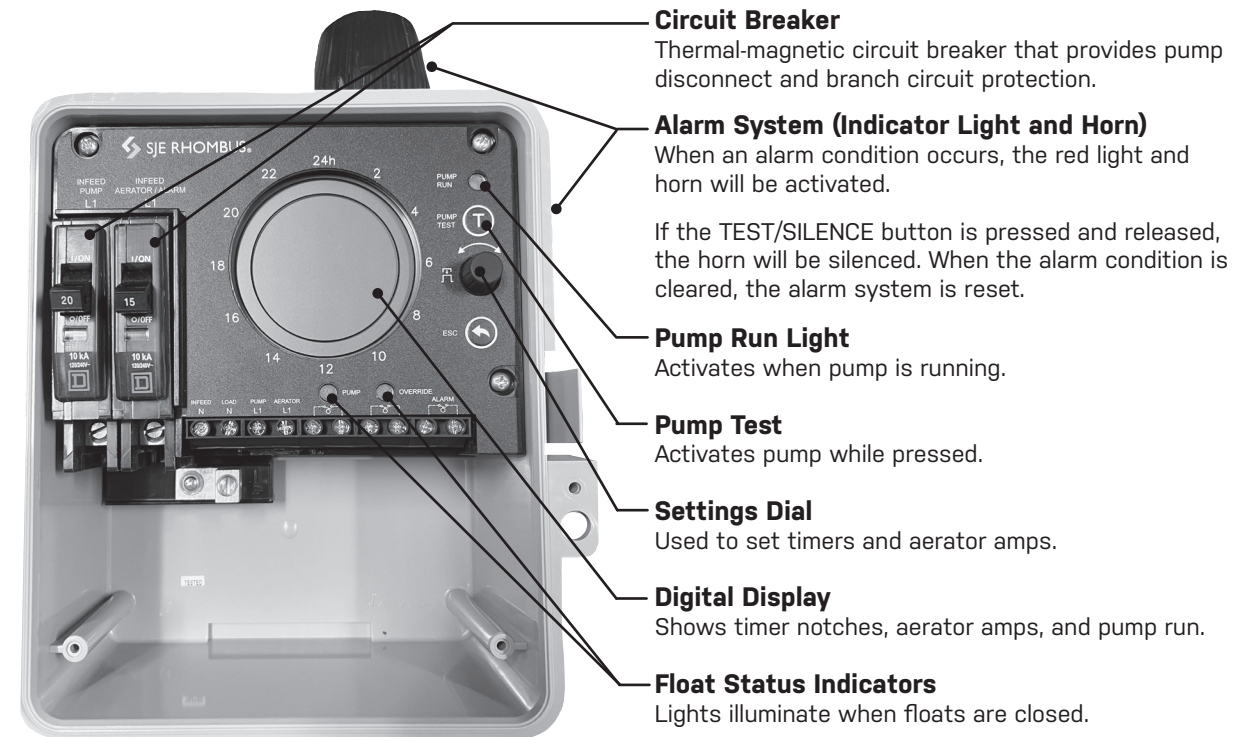

Circuit Breaker

Thermal-magnetic circuit breaker that provides pump disconnect and branch circuit protection.

Alarm System (Indicator Light and Horn)

When an alarm condition occurs, the red light and horn will be activated.

If the TEST/SILENCE button is pressed and released, the horn will be silenced. When the alarm condition is cleared, the alarm system is reset.

Pump Run Light

Activates when pump is running.

Pump Test

Activates pump while pressed.

Settings Dial

Used to set timers and aerator amps.

Digital Display

Shows timer notches, aerator amps, and pump run.

Float Status Indicators

Lights illuminate when floats are closed.

⚠️ CAUTION!

You must use conduit sealant to prevent moisture or gases from entering the panel.

Type 4X conduit must be used to maintain a Type 4X rating of the control panel.



Technical support, service questions:

+1-800-Rhombus (+1-800-746-6287)

Monday - Friday 7:00 AM to 6:00 PM Central Time